



HOSHIZAKI

Parts List

Modular Flaker

Models

F-1001MAJ(-C)

F-1001MWJ(-C)

F-1001MRJ(-C)

F-1001MLJ



hoshizakiamerica.com

Number: 71355
Issued: 8-28-2014
Revised: 2-2-2017

CONTENTS

Note About Ordering Parts	3
A. Main Assembly & Refrigeration Circuit	4
F-1001MAJ(-C)	4
F-1001MWJ(-C)	7
F-1001MRJ(-C)	10
F-1001MLJ.....	13
B. Icemaking Unit	16
C. Water Circuit.....	18
D. Control Box Assembly.....	20
E. Accessories & Labels	22

Auxiliary Codes

F-1001MAJ

D-0 July 2014
E-0 January 2015
F-0 January 2016

F-1001MWJ

D-0 September 2014
E-0 February 2015
F-0 April 2016

F-1001MRJ

D-1 September 2014
E-0 January 2015
F-0 January 2016

F-1001MLJ

D-0 September 2014
E-0 January 2015
F-0 May 2016

F-1001MAJ-C

D-0 July 2014
E-0 January 2015
F-0 January 2016

F-1001MWJ-C

D-0 September 2014
E-0 January 2015
F-0 January 2016

F-1001MRJ-C

D-0 July 2014
D-1 September 2014
E-0 January 2015
F-0 January 2016

Auxiliary Code Breakdown

The auxiliary code is the first two characters in the serial number. The first character indicates the year. Years progress or regress in alphabetical order. The series runs from "A" through "V" and the letters "I" and "O" are skipped. The second character indicates significant part changes within a year. Base is "0" and this number advances for each change. In cases where there is a letter in parentheses, this designates the month. This is the last character in the serial number. The series runs from "(A)" through "(M)" and the letter "(I)" is skipped. This designation is only included when identifying a parts change within an auxiliary code.

Note About Ordering Parts

Most assemblies cannot be ordered as complete units; parts in the assemblies generally must be ordered separately.

A. Main Assembly & Refrigeration Circuit
F-1001MAJ(-C)
 D-0 to F-0

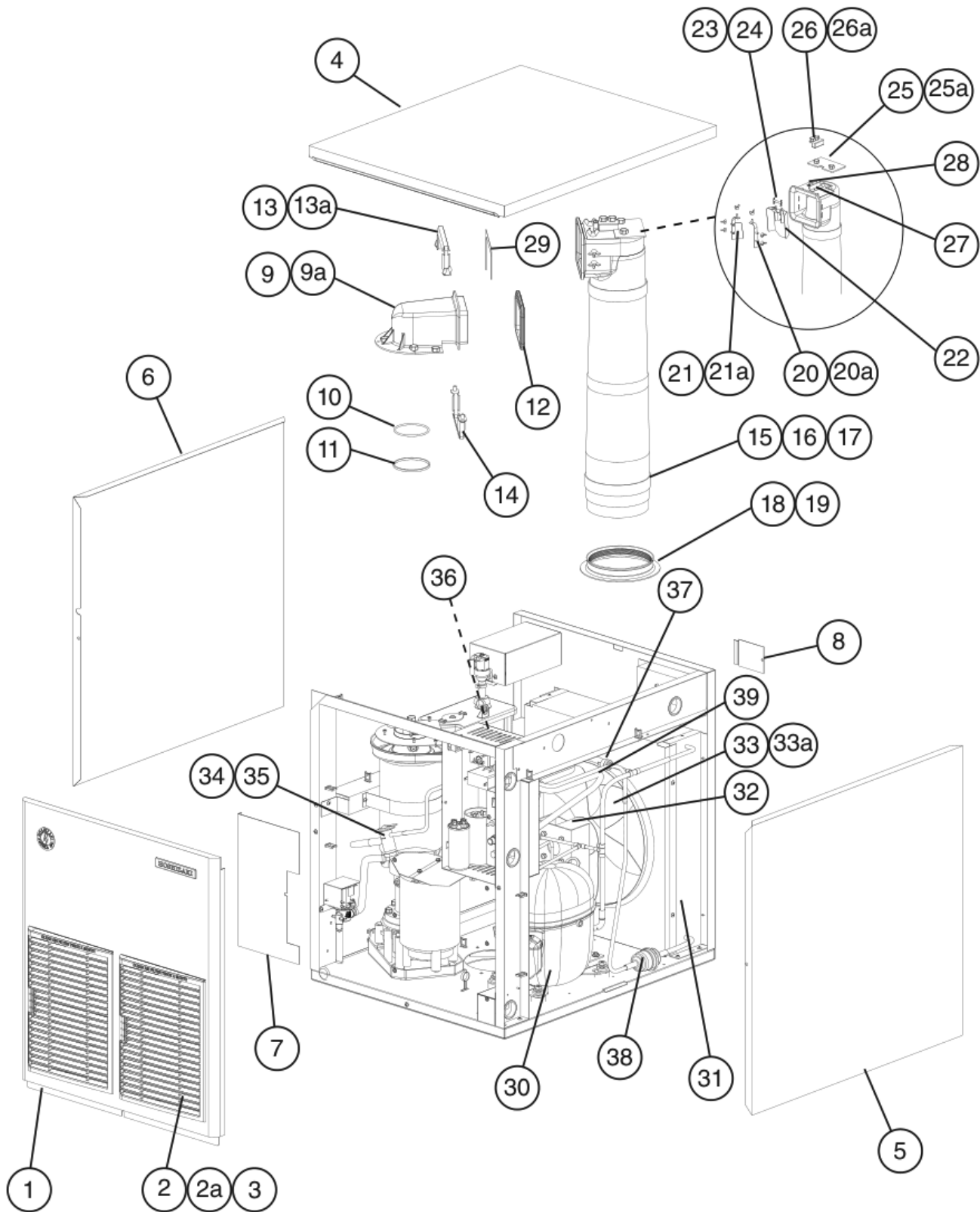

Title: A. Main Assembly & Refrigeration Circuit Model: F-1001MAJ(-C)											
Index No.	Description	Material or Model Number	Part Number	D-0 to F-0	Required Number						
Main Assembly											
1	Front Panel		2A2071-01	1							
2	Louver		1A0548-01	2							
2a	Push Retainer		4A2414-01	6							
3	Air Filter		2A2063G01	2							
4	Top Panel		2A2064-01	1							
5	Right Side Panel		2A2073G01	1							
6	Left Side Panel		2A2072G01	1							
7	Control Box Cover		3A0411-01	1							
8	Junction Box Cover		433410-01	1							
9	Spout		104797-01	1							
9a	Thumbscrew		415949G08	5							
10	O-Ring		4A4755-03	1							
11	Nylon Ring		432661-02	1							
12	Spout-to-Chute Packing		321037-01	1							
13	Upper Strap		328703-02	1							
13a	Wing Nut		7E12-0600	2							
14	Lower Strap		321038G02	1							
15	Chute		2A1919-01	1							
16	Chute Insulation		2A1920-01	1							
17	Chute Tie		436531G01	3							
18	Chute Packing		432877-01	1							
19	Ring		3A1017-01	1							
20	Chute Baffle A		3A0400G01	1							
20a	Wing Nut		7E12-0400	3							
21	Chute Baffle B		3A0399G01	1							
21a	Wing Nut		7E12-0400	3							
22	Actuator		436848G01	1							
23	Shaft		436851-01	1							
24	Snap Pin		715S-0005	2							
25	Plate		4A2039-01	1							
25a	Thumbscrew		415949G10	2							
26	Mechanical Bin Control (proximity switch)		4A2033-01	1							
26a	Thumbscrew		415949G08	2							
27	Mechanical Bin Control Bracket		3A1744G01	1							
28	Truss Head Screw (ground)		7C32-0408	1							
29	Spout-to-Chute Bracket		4A1712-01	1							

Title: A. Main Assembly & Refrigeration Circuit Model: F-1001MAJ(-C)												
Index No.	Description	Material or Model Number	Part Number	D-0 to F-0	Required Number							
Refrigeration Circuit												
30	Compressor		4A5669-01	1								
31	Condenser		211663-02	1								
32	Fan Motor		4A3158-01	1								
33	Fan Blade		4A0197-01	1								
33a	Self-Locking Nut	8-32	7N2110832	4								
34	Thermostatic Expansion Valve		4A1117-01	1								
35	Thermostatic Expansion Valve Cover		4A1168-01	1								
36	Thermostatic Expansion Valve Bulb Holder		3A0112-01	1								
37	High-Pressure Switch		463180-04	1								
38	Drier		4A2666-01	1								
39	Heat Exchanger		3A7886G01	1								

A. Main Assembly & Refrigeration Circuit
F-1001MWJ(-C)
 D-0 to F-0

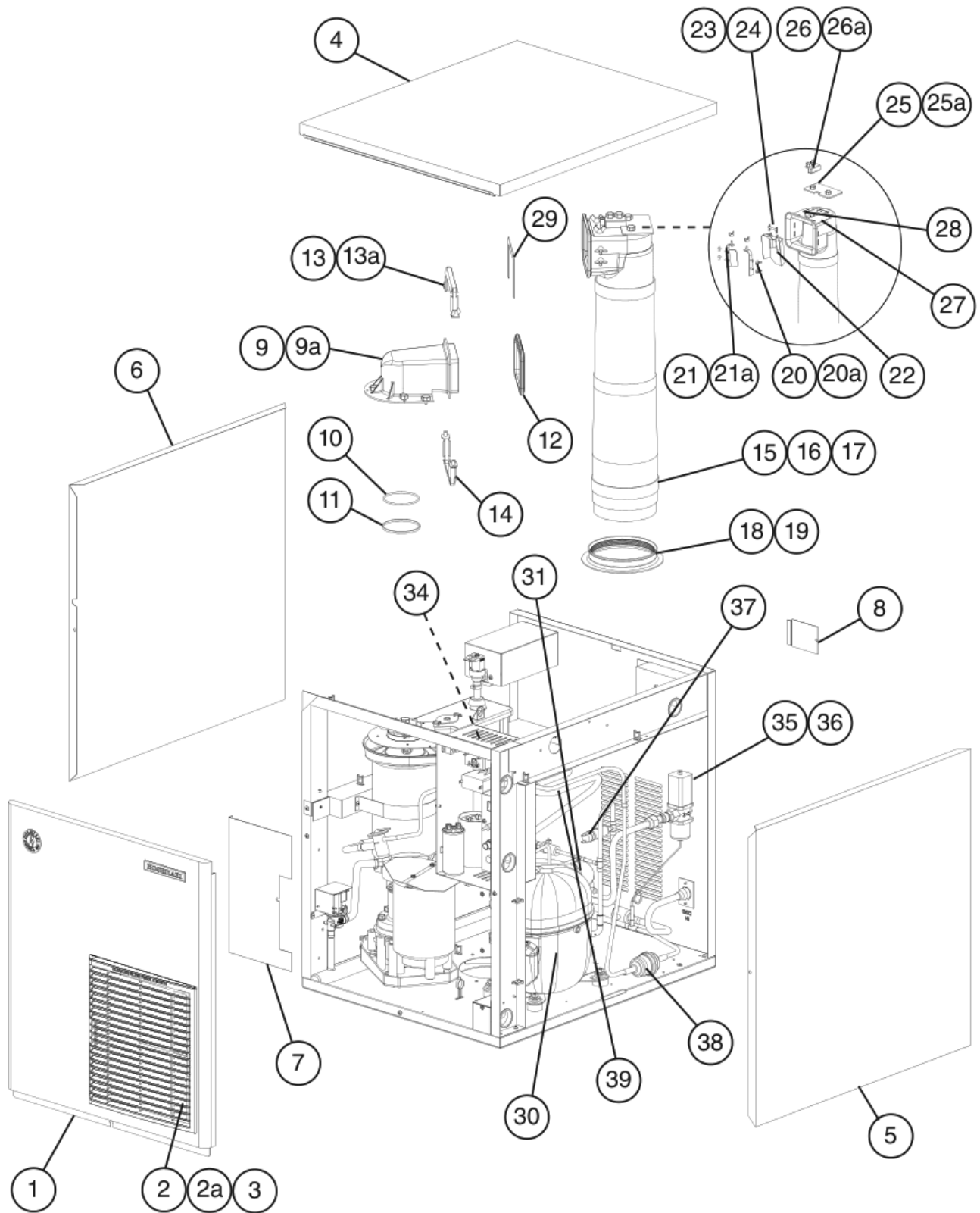

Title: A. Main Assembly & Refrigeration Circuit Model: F-1001MWJ(-C)

Index No.	Description	Material or Model Number	Part Number	Required Number							
				D-0 to F-0							
Main Assembly											
1	Front Panel		2A2124-01	1							
2	Louver		1A0547-01	1							
2a	Push Retainer		4A2414-01	3							
3	Air Filter		2A2062G01	1							
4	Top Panel		2A2064-01	1							
5	Right Side Panel		2A2073G01	1							
6	Left Side Panel		2A2072G01	1							
7	Control Box Cover		3A0411-01	1							
8	Junction Box Cover		433410-01	1							
9	Spout		104797-01	1							
9a	Thumbscrew		415949G08	5							
10	O-Ring		4A4755-03	1							
11	Nylon Ring		432661-02	1							
12	Spout-to-Chute Packing		321037-01	1							
13	Upper Strap		328703-02	1							
13a	Wing Nut		7E12-0600	2							
14	Lower Strap		321038G02	1							
15	Chute		2A1919-01	1							
16	Chute Insulation		2A1920-01	1							
17	Chute Tie		436531G01	3							
18	Chute Packing		432877-01	1							
19	Ring		3A1017-01	1							
20	Chute Baffle A		3A0400G01	1							
20a	Wing Nut		7E12-0400	3							
21	Chute Baffle B		3A0399G01	1							
21a	Wing Nut		7E12-0400	3							
22	Actuator		436848G01	1							
23	Shaft		436851-01	1							
24	Snap Pin		715S-0005	2							
25	Plate		4A2039-01	1							
25a	Thumbscrew		415949G10	2							
26	Mechanical Bin Control (proximity switch)		4A2033-01	1							
26a	Thumbscrew		415949G08	2							
27	Mechanical Bin Control Bracket		3A1744G01	1							
28	Truss Head Screw (Ground)		7C32-0408	1							
29	Spout-to-Chute Bracket		4A1712-01	1							

Title: A. Main Assembly & Refrigeration Circuit Model: F-1001MWJ(-C)											
Index No.	Description	Material or Model Number	Part Number	D-0 to F-0	Required Number						
Refrigeration Circuit											
30	Compressor		4A5669-01	1							
31	Condenser		3A7321-01	1							
32	Thermostatic Expansion Valve		4A1117-01	1							
33	Thermostatic Expansion Valve Cover		4A1168-01	1							
34	Thermostatic Expansion Valve Bulb Holder		3A0112-01	1							
35	Water Regulating valve		4A0911-04	1							
36	Male Connector		4A0770-01	1							
37	High-Pressure Switch		463180-05	1							
38	Drier		4A2666-01	1							
39	Heat Exchanger		3A7886G01	1							

A. Main Assembly & Refrigeration Circuit
F-1001MRJ(-C)
 D-0 to F-0

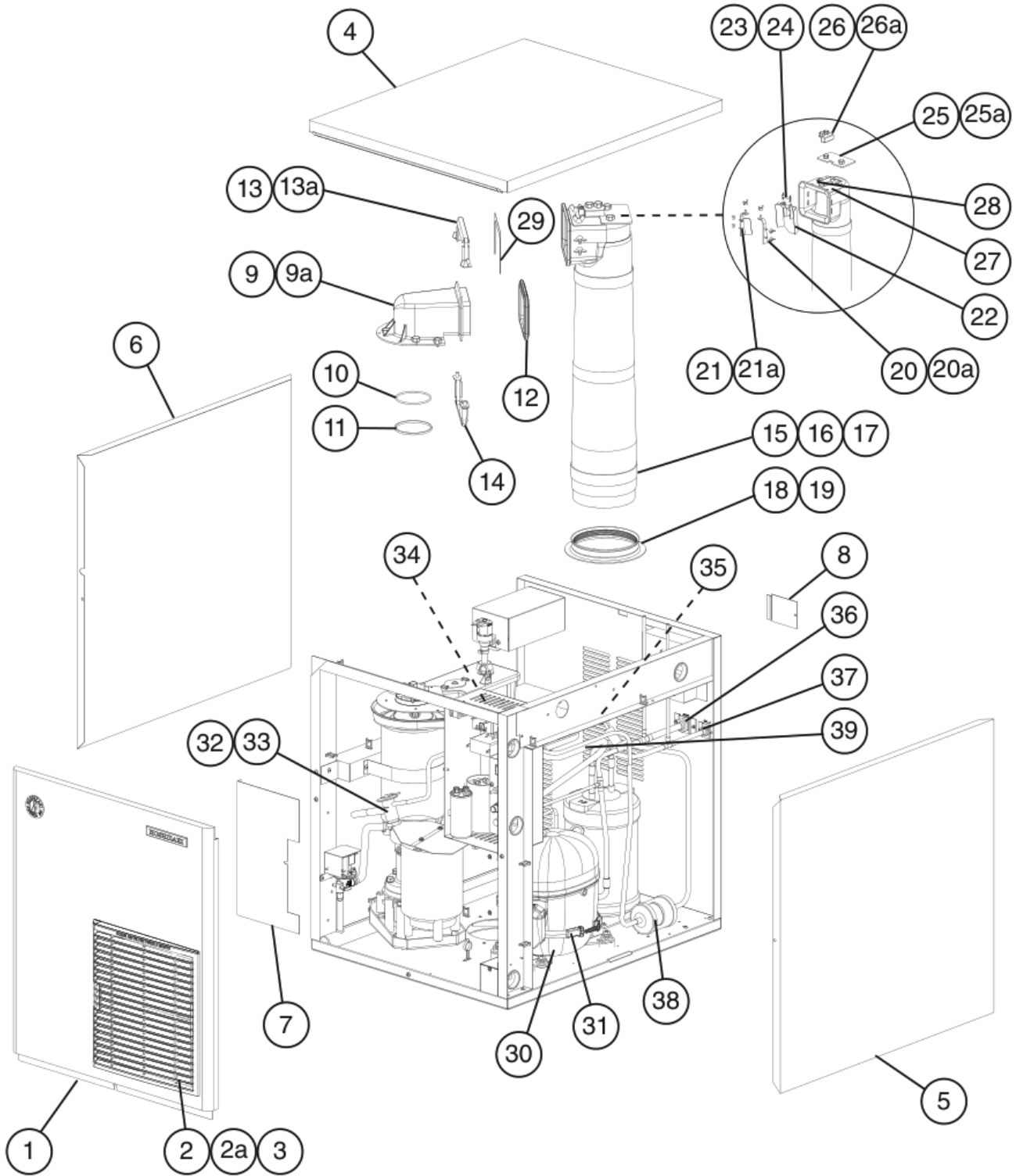

Title: A. Main Assembly & Refrigeration Circuit Model: F-1001MRJ(-C)											
Index No.	Description	Material or Model Number	Part Number	Required Number							
				D-0	D-1 to F-0						
Main Assembly											
1	Front Panel		2A2124-01	1	1						
2	Louver		1A0547-01	1	1						
2a	Push Retainer		4A2414-01	3	3						
3	Air Filter		2A2062G01	1	1						
4	Top Panel		2A2064-01	1	1						
5	Right Side Panel		2A2073G01	1	1						
6	Left Side Panel		2A2072G01	1	1						
7	Control Box Cover		3A0411-01	1	1						
8	Junction Box Cover		433410-01	2	2						
9	Spout		104797-01	1	1						
9a	Thumbscrew		415949G08	5	5						
10	O-Ring		4A4755-03	1	1						
11	Nylon Ring		432661-02	1	1						
12	Spout-to-Chute Packing		321037-01	1	1						
13	Upper Strap		328703-02	1	1						
13a	Wing Nut		7E12-0600	2	2						
14	Lower Strap		321038G02	1	1						
15	Chute		2A1919-01	1	1						
16	Chute Insulation		2A1920-01	1	1						
17	Chute Tie		436531G01	3	3						
18	Chute Packing		432877-01	1	1						
19	Ring		3A1017-01	1	1						
20	Chute Baffle A		3A0400G01	1	1						
20a	Wing Nut		7E12-0400	3	3						
21	Chute Baffle B		3A0399G01	1	1						
21a	Wing Nut		7E12-0400	3	3						
22	Actuator		436848G01	1	1						
23	Shaft		436851-01	1	1						
24	Snap Pin		715S-0005	2	2						
25	Plate		4A2039-01	1	1						
25a	Thumbscrew		415949G10	2	2						
26	Mechanical Bin Control (proximity switch)		4A2033-01	1	1						
26a	Thumbscrew		415949G08	2	2						
27	Mechanical Bin Control Bracket		3A1744G01	1	1						
28	Truss Head Screw (Ground)		7C32-0408	1	1						
29	Spout-to-Chute Bracket		4A1712-01	1	1						

Title: A. Main Assembly & Refrigeration Circuit Model: F-1001MRJ(-C)												
Index No.	Description	Material or Model Number	Part Number	Required Number								
				D-0	D-1 to F-0							
Refrigeration Circuit												
30	Compressor		4A5669-01	1	1							
31	Crankcase Heater		4A5091-01	1	1							
32	Thermostatic Expansion Valve		4A1117-01	1	-							
			4A3493-01		1							
33	Thermostatic Expansion Valve Cover		4A1168-01	1	1							
34	Thermostatic Expansion Valve Bulb Holder		3A0112-01	1	1							
35	High-Pressure Switch		463180-04	1	1							
36	Discharge Line Coupling		434072-01	1	1							
37	Liquid Line Coupling		426554-01	1	1							
38	Drier		4A1338-01	1	1							
39	Heat Exchanger		3A7886G01	1	1							

A. Main Assembly and Refrigeration Circuit
F-1001MLJ
 D-0 to F-0

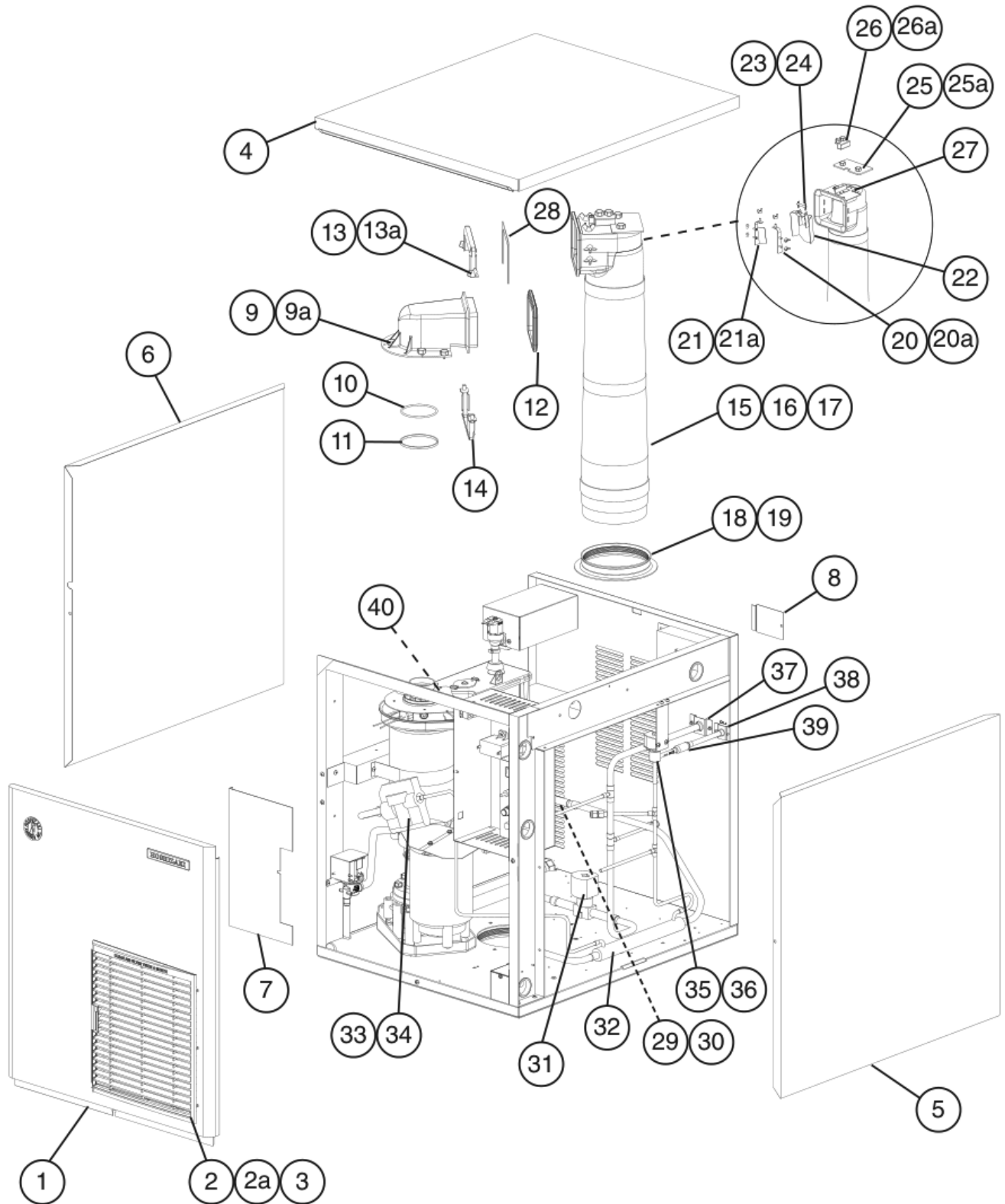

Title: A. Main Assembly & Refrigeration Circuit Model: F-1001MLJ(-C)											
Index No.	Description	Material or Model Number	Part Number	Required Number							
				D-0 to F-0							
Main Assembly											
1	Front Panel		2A2124-01	1							
2	Louver		1A0547-01	1							
2a	Push Retainer		4A2414-01	3							
3	Air Filter		2A2062G01	1							
4	Top Panel		2A2064-01	1							
5	Right Side Panel		2A2073G01	1							
6	Left Side Panel		2A2072G01	1							
7	Control Box Cover		3A0411-01	1							
8	Junction Box Cover		433410-01	1							
9	Spout		104797-01	1							
9a	Thumbscrew		415949G08	5							
10	O-Ring		4A4755-03	1							
11	Nylon Ring		432661-02	1							
12	Spout-to-Chute Packing		321037-01	1							
13	Upper Strap		328703-02	1							
13a	Wing Nut		7E12-0600	2							
14	Lower Strap		321038G02	1							
15	Chute		2A1919-01	1							
16	Chute Insulation		2A1920-01	1							
17	Chute Tie		436531G01	1							
18	Chute Packing		432877-01	1							
19	Ring		3A1017-01	1							
20	Chute Baffle A		3A0400G01	1							
20a	Wing Nut		7E12-0400	3							
21	Chute Baffle B		3A0399G01	1							
21a	Wing Nut		7E12-0400	3							
22	Actuator		436848G01	1							
23	Shaft		436851-01	1							
24	Snap Pin		715S-0005	2							
25	Plate		4A2039-01	1							
25a	Thumbscrew		415949G10	2							
26	Bin Control (proximity switch)		4A2033-01	1							
26a	Thumbscrew		415949G08	2							
27	Bin Control Bracket (proximity switch)		3A1744G01	1							
28	Spout-to-Chute Bracket		4A1712-01	1							

Title: A. Main Assembly & Refrigeration Circuit Model: F-1001MLJ(-C)											
Index No.	Description	Material or Model Number	Part Number	D-0 to F-0	Required Number						
Refrigeration Circuit											
29	Evaporator Pressure Regulator (EPR) Valve		4A1384-01	1							
30	Evaporator Pressure Regulator (EPR) Valve Cover		340434-01	1							
31	Suction Line Valve		446873-01	1							
32	Heat Exchanger		4A1374-01	1							
33	Thermostatic Expansion Valve		4A1117-01	1							
34	Thermostatic Expansion Valve Cover		4A1168-01	1							
35	Liquid Line Valve Body		4A3276-01	1							
36	Valve Coil		4A3277-01	1							
37	Discharge Line Coupling		434132G01	1							
38	Liquid Line Coupling		433751G01	1							
39	Strainer		4A1385-01	1							
40	Thermostatic Expansion Valve Bulb Holder		438246-01	1							

B. Icemaking Unit
F-1001M_J(-C)
 D-0 to F-0

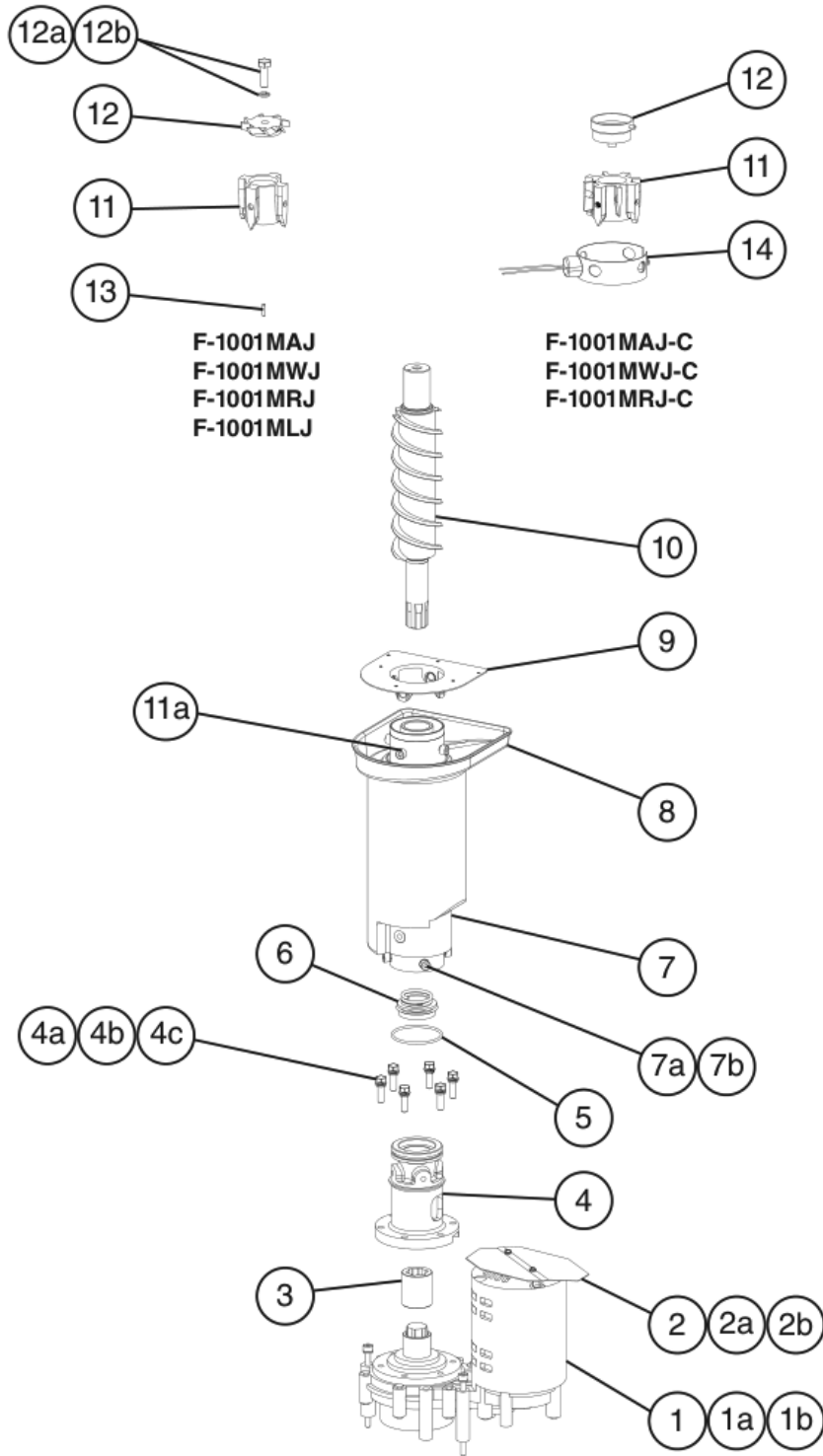

Title: B. Icemaking Unit Model: F-1001M_J(-C)											
Index No.	Description	Material or Model Number	Part Number	D-0 to F-0	Required Number						
1	Gear Motor		4A2007-01	1							
1a	Socket Head Cap Screw		7S12-0811	3							
1b	Split Lock Washer		7L22-0800	3							
2	Gear Motor Barrier		4A4029-01	1							
2a	Truss Head Screw		7C32-0408	2							
2b	Washer		4A5268-01	2							
3	Spline Coupling		414137-01	1							
4	Housing		2A1977G01	1							
4a	Hex Head Bolt	8x30, SS	7B02-0830	6							
4b	Plain Washer		7W22-0800	6							
4c	Split Lock Washer		7L22-0800	6							
5	O-Ring		4A4755-02	1							
6	Mechanical Seal		432492-01	1							
7	Evaporator		2A7209G01	1							
7a	Socket Head Cap Screw	8x12, SS	7S12-0812	4							
7b	Split Lock Washer		7L22-0800	4							
8	Drip Pan		2A7187-01	1							
9	Flange		352713-01	1							
10	Auger		120863G02	1							
11	Extruding Head	F-1001M_J	3A2175G01	1							
		F-1001M_J-C	3A2176G01	1							
11a	Seal Bolt		P01768-01	4							
12	Cutter	F-1001M_J	3A1395-02	1							
		F-1001M_J-C	427183G01	1							
12a	Hex Head Bolt	F-1001M_J	7B02-1030	1							
12b	Split Lock Washer	F-1001M_J	7L22-1000	1							
13	Dowel Pin	F-1001M_J	713S-0416	1							
14	Evaporator Heater	F-1001M_J-C	4A2292-01	1							

C. Water Circuit
F-1001M_J(-C)
D-0 to F-0

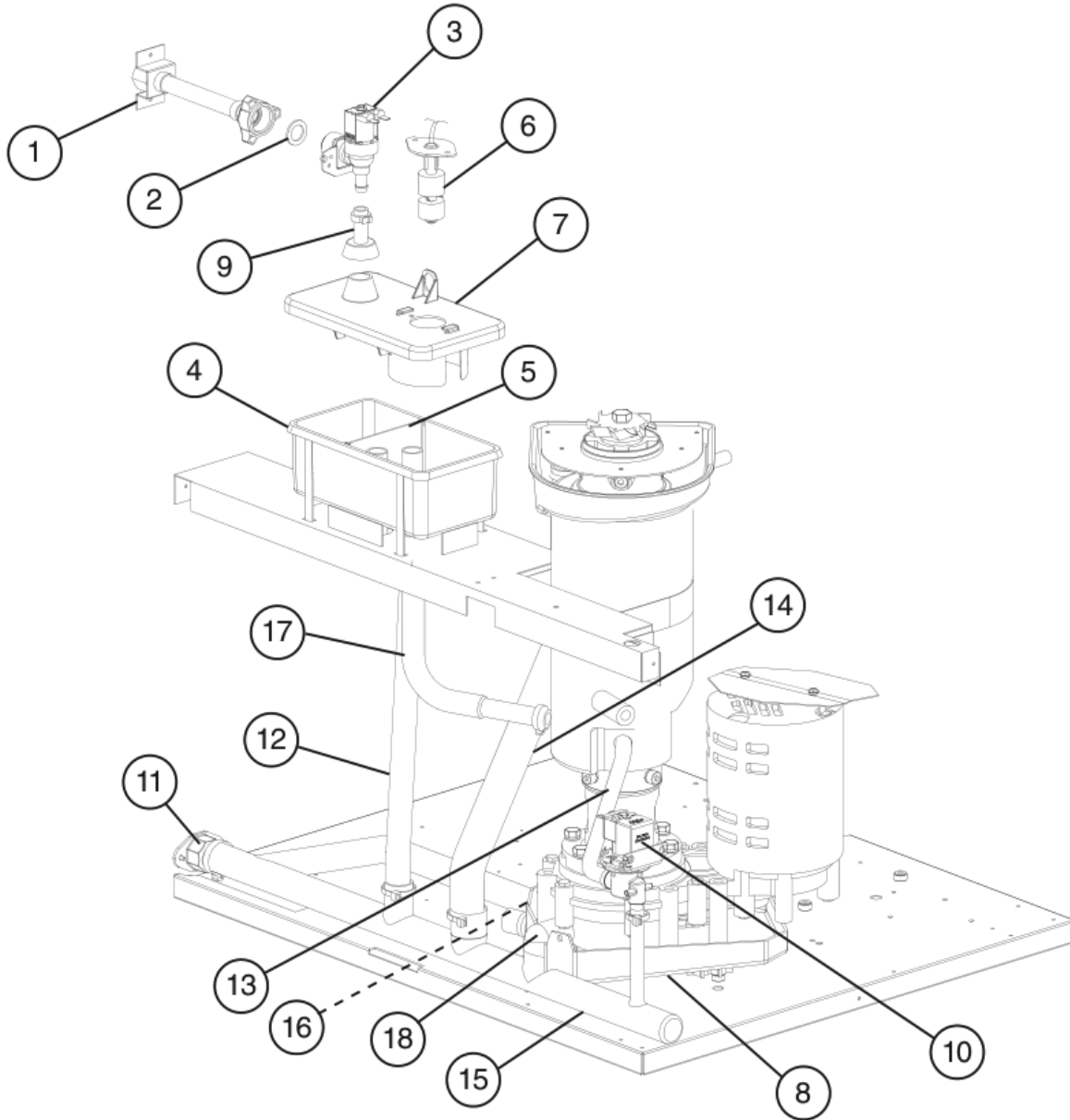

Title: C. Water Circuit Model: F-1001M_J(-C)												
Index No.	Description	Material or Model Number	Part Number	D-0 to F-0	Required Number							
1	Water Supply Pipe		4A0891G02	1								
2	Washer		413854-03	1								
3	Inlet Water Valve		4A5309-01	1								
4	Reservoir		2A0753-01	1								
5	Reservoir Separator		4A1255-01	1								
6	Float Switch		435490-01	1								
7	Reservoir Cover		214810-01	1								
8	Drain Pan		323765G02	1								
9	Reservoir Inlet		4A0869-01	1								
10	Drain Valve		4A2772-02	1								
11	Drain Fitting		4A5528-01	1								
12	Vinyl Hose	L=375 mm	7725-1923	1								
13	Silicone Hose	L=185 mm	7730 3896	1								
14	Vinyl Hose	L=460 mm	4A0658L01	1								
15	Drain Hose		3A8170-01	1								
16	Vinyl Hose	L=30 mm	7725-1923	1								
17	Reservoir Hose		4A1165-06	1								
18	Elbow		4A5624-01	1								
Clamps												
	Hose Clamp	26-30 mm	4A2017-02	1								
	Hose Clamp	17-20 mm	4A2017-05	1								
	Hose Clamp	19-22 mm	4A2017-06	1								
	Hose Clamp	14-15 mm	4A2017-08	1								

D. Control Box Assembly
F-1001M_J(-C)
D-0 to F-0

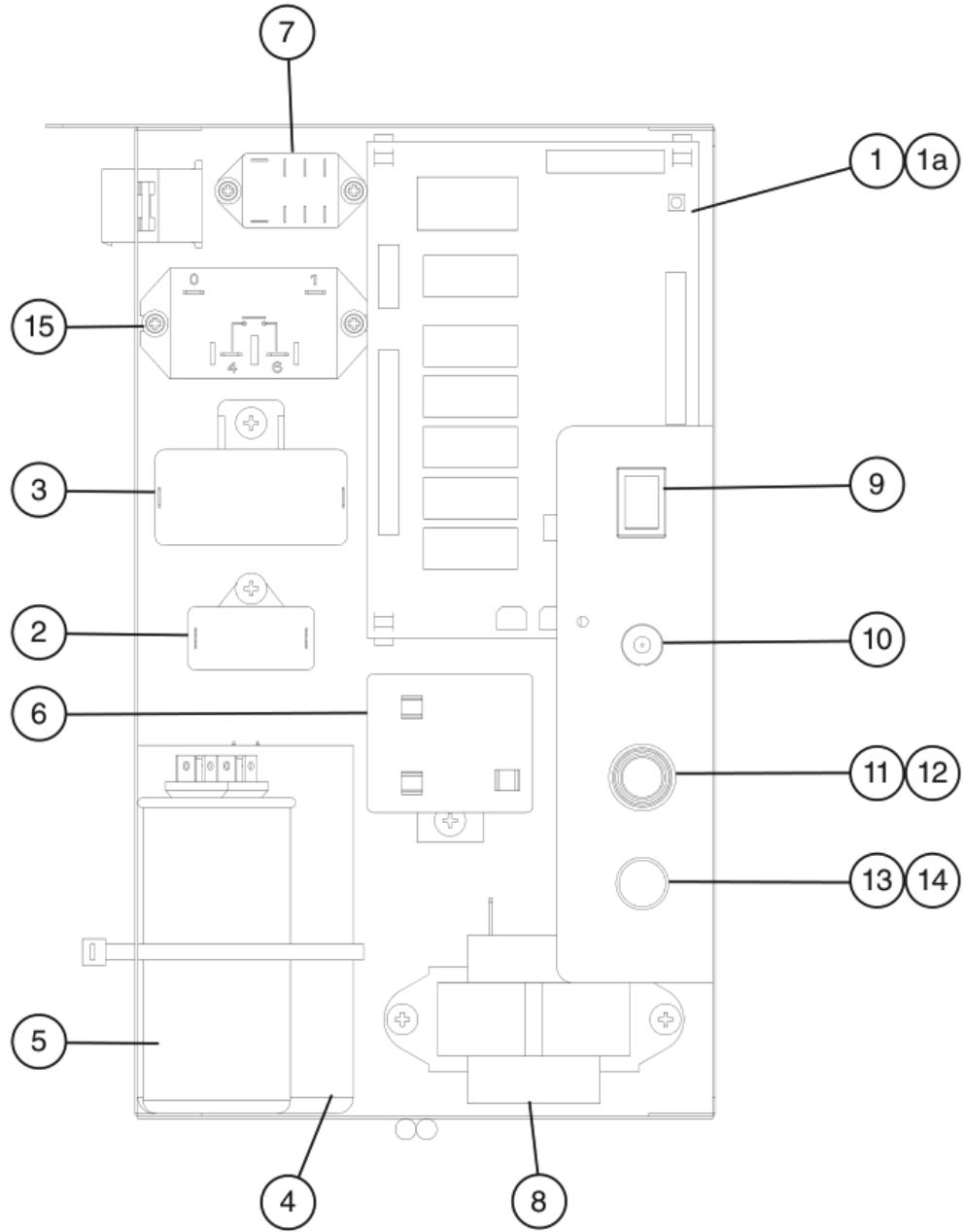

Title: D. Control Box Assembly Model: F-1001M_J(-C)											
Index No.	Description	Material or Model Number	Part Number	D-0 to F-0	Required Number						
1	"F-C" Control Board		2A8054-01	1							
1a	Control Board Support		4A0336-03	4							
2	Fan Motor Capacitor	F-1001MAJ(-C) 5MFD, 250VAC	443192-02	1							
3	Gear Motor Capacitor	24MFD, 250VAC	4A2273-01	1							
4	Start Capacitor (all except F-1001MLJ)	340-408MFD, 250VAC	3A0076-24	1							
5	Run Capacitor (all except F-1001MLJ)	40MFD, 370VAC	3A2005-13	1							
6	Start Relay (all except F-1001MLJ)		4A1107-22	1							
7	Compressor Control Relay	110/120VAC	406132-07	1							
8	Control Transformer		4A0557-01	1							
9	Control Switch		4A0558-01	1							
10	Power Switch		4A2332-01	1							
11	Fuse Holder (control)		4A5443-01	1							
12	Fuse (control)	AGC-1A, 250VAC	4A0893-01	1							
13	Fuse Holder (gear motor)		4A3449-02	1							
14	Fuse (gear motor)	GMD-3A, 250VAC Slow Blow	4A0893-06	1							
15	Compressor Relay (all except F-1001MLJ)	115VAC	4A3140-01	1							

E. Accessories & Labels
F-1001M_J(-C)
 D-0 to F-0

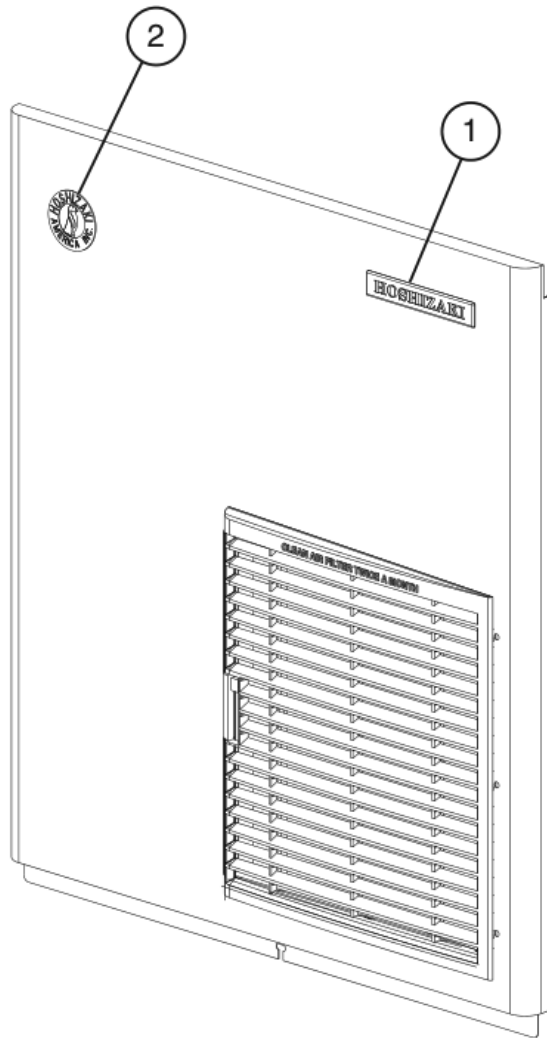

Title: E. Accessories & Labels Model: F-1001M_J(-C)											
Index No.	Description	Material or Model Number	Part Number	Required Number							
				D-0 to F-0							
1	Hoshizaki Emblem Label		4A0560-01	1							
2	Penguin Label		4A0526-01	1							
3	Universal Brace		4A0363-01	2							
3a	Hex Bolt		7B02-0512	2							