



HOSHIZAKI

Parts List

Modular Flaker

F-1501MAH(-C)

F-1501MWH(-C)

F-1501MRH(-C)



hoshizakiamerica.com

Number: 71353
Issued: 7-9-2014
Revised: 12-17-2019

CONTENTS

Note About Ordering Parts	3
A. Main Assembly & Refrigeration Circuit	4
F-1501MAH(-C)	4
F-1501MWH(-C)	7
F-1501MRH(-C)	10
B. Icemaking Unit	13
C. Water Circuit	15
D. Control Box Assembly	17
E. Accessories & Labels	19

Auxiliary Codes

F-1501MAH

D-0 May 2014
E-0 February 2015
F-0 January 2016

F-1501MWH

D-0 July 2014
E-0 February 2015
F-0 February 2016

F1501MRH

D-0 May 2014
E-0 January 2015
F-0 February 2016

F-1501MAH-C

D-0 June 2014
E-0 January 2015
F-0 January 2016

F-1501MWH-C

D-0 June 2014
E-0 January 2015
F-0 March 2016

F-1501MRH-C

D-0 April 2014
E-0 January 2015
F-0 January 2016

Auxiliary Code Breakdown

The auxiliary code is the first two characters in the serial number. The first character indicates the year. Years progress or regress in alphabetical order. The series runs from "A" through "V" and the letters "I" and "O" are skipped. The second character indicates significant part changes within a year. Base is "0" and this number advances for each change. In cases where there is a letter in parentheses, this designates the month. This is the last character in the serial number. The series runs from "(A)" through "(M)" and the letter "(I)" is skipped. This designation is only included when identifying a parts change within an auxiliary code.

Note About Ordering Parts

Most assemblies cannot be ordered as complete units; parts in the assemblies generally must be ordered separately.

A. Main Assembly & Refrigeration Circuit
F-1501MAH(-C)
 D-0 to F-0

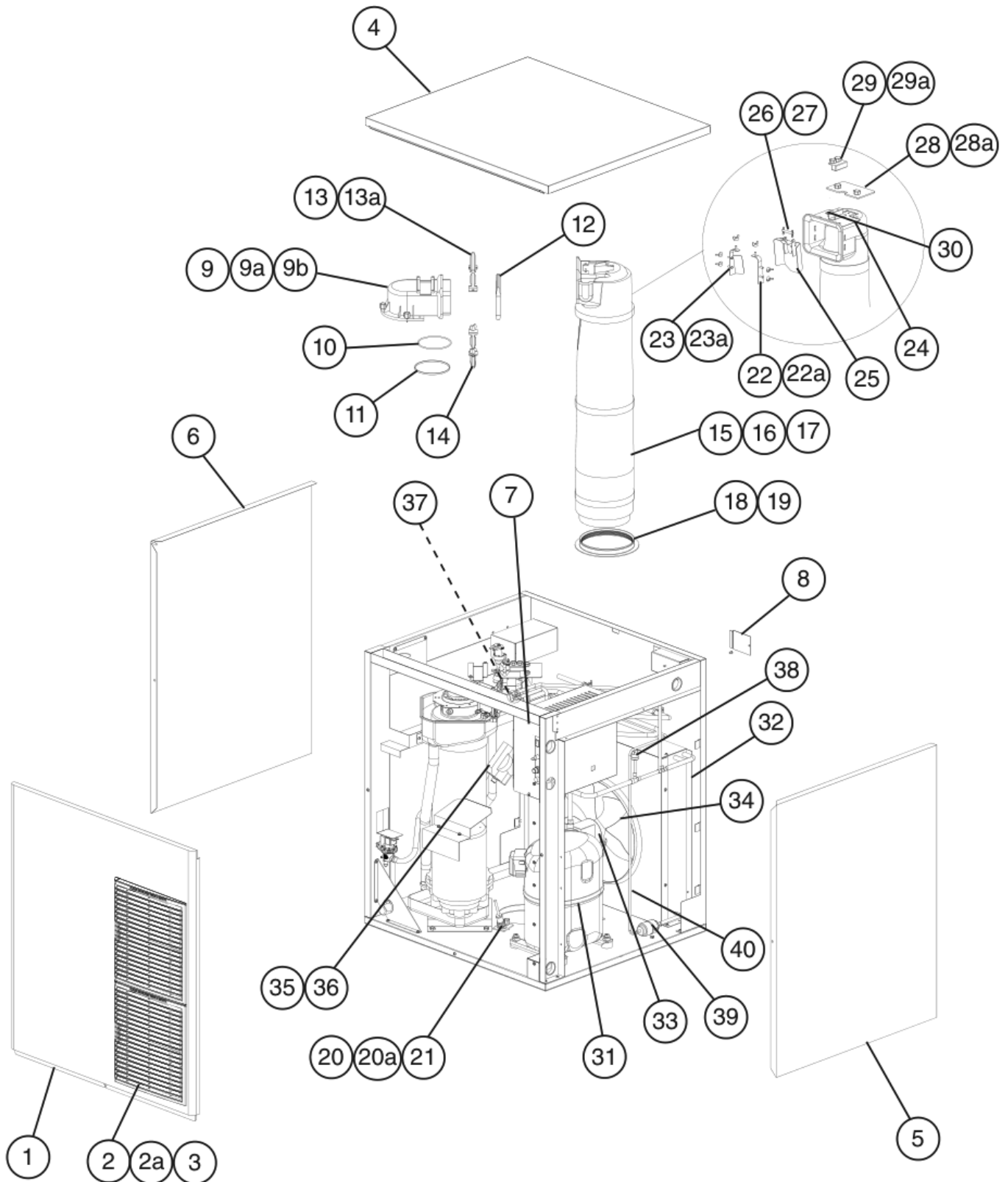

Title: A. Main Assembly & Refrigeration Circuit Model: F-1501MAH(-C)										
Index No.	Description	Material or Model Number	Part Number	D-0 to F-0	Required Number					
Main Assembly										
1	Front Panel		2A2203-01	1						
2	Louver		1A0547-01	2						
2a	Push Retainer		4A2414-01	6						
3	Air Filter		2A2062G01	2						
4	Top Panel		2A2074-01	1						
5	Right Side Panel		2A2077G01	1						
6	Left Side Panel		2A2076G01	1						
7	Control Box Cover		3A7897-01	1						
8	Junction Box Cover		433410-01	1						
9	Spout		105378G01	1						
9a	Thumbscrew		415949G11	3						
9b	Spout Cover		4A5174-01	1						
10	O-ring		4A4755-05	1						
11	Nylon Ring		431736-01	1						
12	Chute Packing		327040-01	1						
13	Upper Strap		3A6912-02	1						
13a	Wing Nut		7E12-0600	2						
14	Lower Strap		3A6912-01	1						
15	Chute		216219-01	1						
16	Chute Insulation		216220-01	1						
17	Chute Tie		436531G02	3						
18	Chute Packing		432877-02	1						
19	Ring		327427-01	1						
20	Bin Control 1 Housing (infrared sensor)		3A3478-01	1						
20a	Thumbscrew		415949G11	1						
21	Bin Control 1 (infrared sensor)		4A4469-01	1						
22	Chute Baffle A		341012G01	1						
22a	Wing Nut		7E12-0400	3						
23	Chute Baffle B		341013G01	1						
23a	Wing Nut		7E12-0400	3						
24	Bin Control 2 Bracket (mechanical bin control)		3A1744G01	1						
25	Actuator		436848G02	1						
26	Shaft		436851-01	1						
27	Snap Pin		715S-0005	2						
28	Plate		4A2039-01	1						
28a	Thumbscrew		415949G10	2						
29	Bin Control 2 Proximity Switch (mechanical bin control)		4A2033-01	1						
29a	Thumbscrew		415949G08	2						
30	Truss Head Screw (ground)		7C32-0408	1						

Title: A. Main Assembly & Refrigeration Circuit Model: F-1501MAH(-C)												
Index No.	Description	Material or Model Number	Part Number	Required Number								
				D-0 to F-0								
Refrigeration Circuit												
31	Compressor		4A1539-03	1								
32	Condenser		2A2215-01	1								
33	Fan Motor		4A3158-01	1								
34	Fan Blade		4A0197-01	1								
35	Thermostatic Expansion Valve		4A1117-01	1								
36	Thermostatic Expansion Valve Cover		4A1168-01	1								
37	Thermostatic Expansion Valve Bulb Holder		4A5641-01	1								
38	High-Pressure Switch		463180-05	1								
39	Drier		4A1113-01	1								
40	Heat Exchanger		3A2978G01	1								

A. Main Assembly & Refrigeration Circuit
F-1501MWH(-C)
 D-0 to F-0

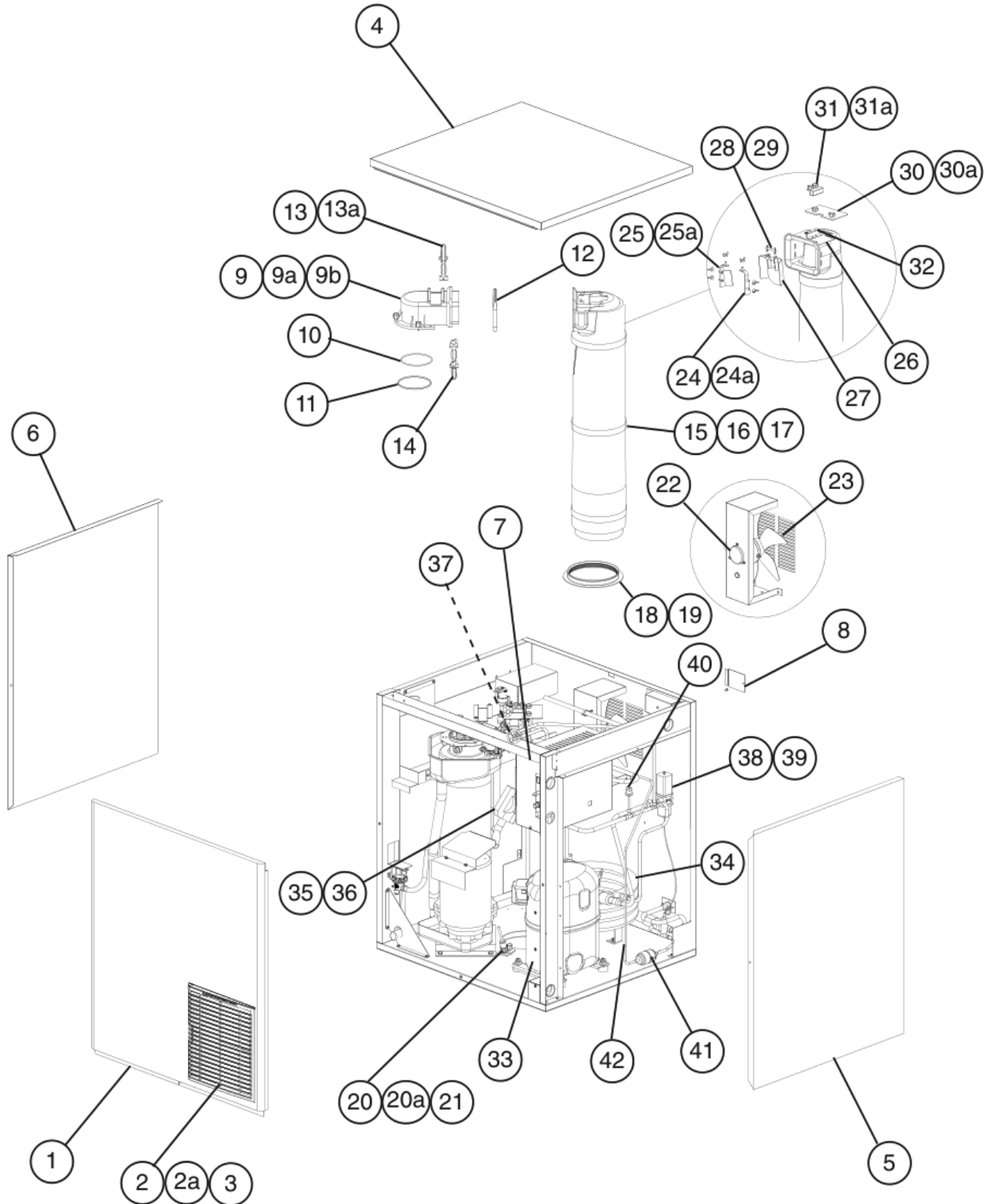

Title: A. Main Assembly & Refrigeration Circuit Model: F-1501MWH(-C)												
Index No.	Description	Material or Model Number	Part Number	D-0 to F-0	Required Number							
Main Assembly												
1	Front Panel		2A2646-01	1								
2	Louver		1A0547-01	1								
2a	Push Retainer		4A2414-01	3								
3	Air Filter		2A2062G01	1								
4	Top Panel		2A2074-01	1								
5	Right Side Panel		2A2077G01	1								
6	Left Side Panel		2A2076G01	1								
7	Control Box Cover		3A7897-01	1								
8	Junction Box Cover		433410-01	1								
9	Spout		105378G01	1								
9a	Thumbscrew		415949G11	3								
9b	Spout Cover		4A5174-01	1								
10	O-ring		4A4755-05	1								
11	Nylon Ring		431736-01	1								
12	Chute Packing		327040-01	1								
13	Upper Strap		3A6912-02	1								
13a	Wing Nut		7E12-0600	2								
14	Lower Strap		3A6912-01	1								
15	Chute		216219-01	1								
16	Chute Insulation		216220-01	1								
17	Chute Tie		436531G02	3								
18	Chute Packing		432877-02	1								
19	Ring		327427-01	1								
20	Bin Control 1 Housing (infrared sensor)		3A3478-01	1								
20a	Thumbscrew		415949G11	1								
21	Bin Control1 (infrared sensor)		4A4469-01	1								
22	Fan Motor		440917-01	1								
23	Fan Blade		434959-01	1								
24	Chute Baffle A		341012G01	1								
24a	Wing Nut		7E12-0400	3								
25	Chute Baffle B		341013G01	1								
25a	Wing Nut		7E12-0400	3								
26	Bin Control 2 Bracket (mechanical bin control)		3A1744G01	1								
27	Actuator		436848G02	1								
28	Shaft		436851-01	1								
29	Snap Pin		715S-0005	2								
30	Plate		4A2039-01	1								
30a	Thumbscrew		415949G10	2								
31	Bin Control 2 Proximity Switch (mechanical bin control)		4A2033-01	1								
31a	Thumbscrew		415949G08	2								
32	Truss Head Screw (ground)		7C32-0408	1								

Title: A. Main Assembly & Refrigeration Circuit Model: F-1501MWH(-C)											
Index No.	Description	Material or Model Number	Part Number	Required Number							
				D-0 to F-0							
Refrigeration Circuit											
33	Compressor		4A1539-03	1							
34	Condenser		3A7236-01	1							
35	Thermostatic Expansion Valve		4A1117-01	1							
36	Thermostatic Expansion Valve Cover		4A1168-01	1							
37	Thermostatic Expansion Valve Bulb Holder		4A5641-01	1							
38	Water Regulating Valve		4A0911-04	1							
39	Male Connector		4A0770-01	1							
40	High-Pressure Switch		463180-05	1							
41	Drier		4A1113-01	1							
42	Heat Exchanger		3A3025G01	1							

A. Main Assembly & Refrigeration Circuit
F-1501MRH(-C)
 D-0 to F-0

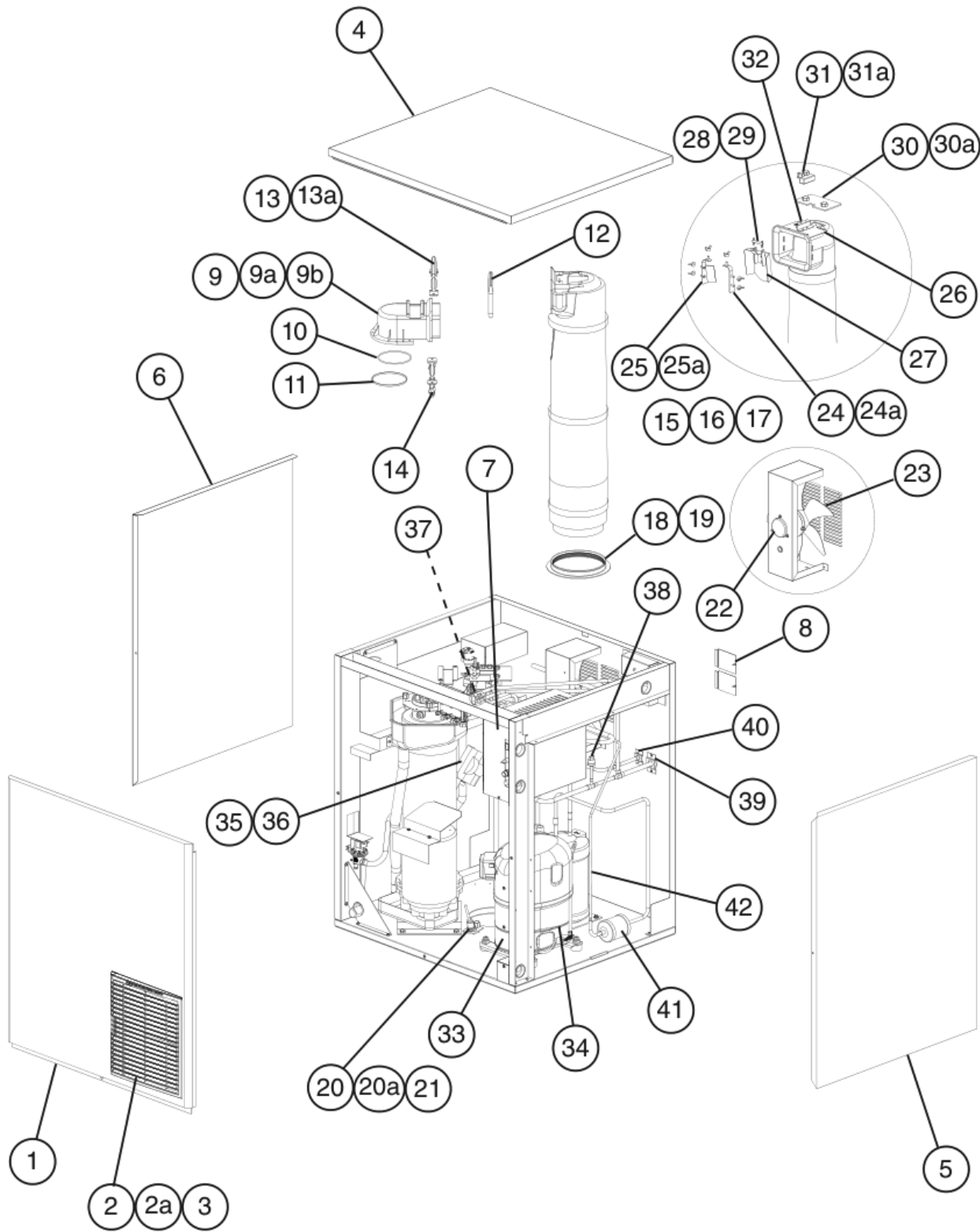

Title: A. Main Assembly & Refrigeration Circuit Model: F-1501MRH(-C)											
Index No.	Description	Material or Model Number	Part Number	Required Number							
				D-0 to F-0							
Main Assembly											
1	Front Panel		2A2646-01	1							
2	Louver		1A0547-01	1							
2a	Push Retainer		4A2414-01	3							
3	Air Filter		2A2062G01	1							
4	Top Panel		2A2074-01	1							
5	Right Side Panel		2A2077G01	1							
6	Left Side Panel		2A2076G01	1							
7	Control Box Cover		3A7897-01	1							
8	Junction Box Cover		433410-01	2							
9	Spout		105378G01	1							
9a	Thumbscrew		415949G11	3							
9b	Spout Cover		4A5174-01	1							
10	O-ring		4A4755-05	1							
11	Nylon Ring		431736-01	1							
12	Chute Packing		327040-01	1							
13	Upper Strap		3A6912-02	1							
13a	Wing Nut		7E12-0600	2							
14	Lower Strap		3A6912-01	1							
15	Chute		216219-01	1							
16	Chute Insulation		216220-01	1							
17	Chute Tie		436531G02	3							
18	Chute Packing		432877-02	1							
19	Ring		327427-01	1							
20	Bin Control 1 Housing (infrared sensor)		3A3478-01	1							
20a	Thumbscrew		415949G11	1							
21	Bin Control 1 (infrared sensor)		4A4469-01	1							
22	Fan Motor		440917-01	1							
23	Fan Blade		434959-01	1							
24	Chute Baffle A		341012G01	1							
24a	Wing Nut		7E12-0400	3							
25	Chute Baffle B		341013G01	1							
25a	Wing Nut		7E12-0400	3							
26	Bin Control 2 Bracket (mechanical bin control)		3A1744G01	1							
27	Actuator		436848G02	1							
28	Shaft		436851-01	1							
29	Snap Pin		715S-0005	2							
30	Plate		4A2039-01	1							
30a	Thumbscrew		415949G10	2							
31	Bin Control 2 Proximity Switch (mechanical bin control)		4A2033-01	1							
31a	Thumbscrew		415949G08	2							
32	Truss Head Screw (ground)		7C32-0408	1							

Title: A. Main Assembly & Refrigeration Circuit Model: F-1501MRH(-C)											
Index No.	Description	Material or Model Number	Part Number	D-0 to F-0	Required Number						
Refrigeration Circuit											
33	Compressor		4A1539-03	1							
34	Crankcase Heater		4A5397-02	1							
35	Thermostatic Expansion Valve		4A1117-01	1							
36	Thermostatic Expansion Valve Cover		4A1168-01	1							
37	Thermostatic Expansion Valve Bulb Holder		4A5641-01	1							
38	High-Pressure Switch		463180-05	1							
39	Discharge Line Coupling		434072-01	1							
40	Liquid Line Coupling		426554-01	1							
41	Drier		4A1338-01	1							
42	Heat Exchanger		3A2995G01	1							

B. Icemaking Unit

F-1501MAH(-C), F-1501MWH(-C), F-1501MRH(-C)

D-0 to F-0

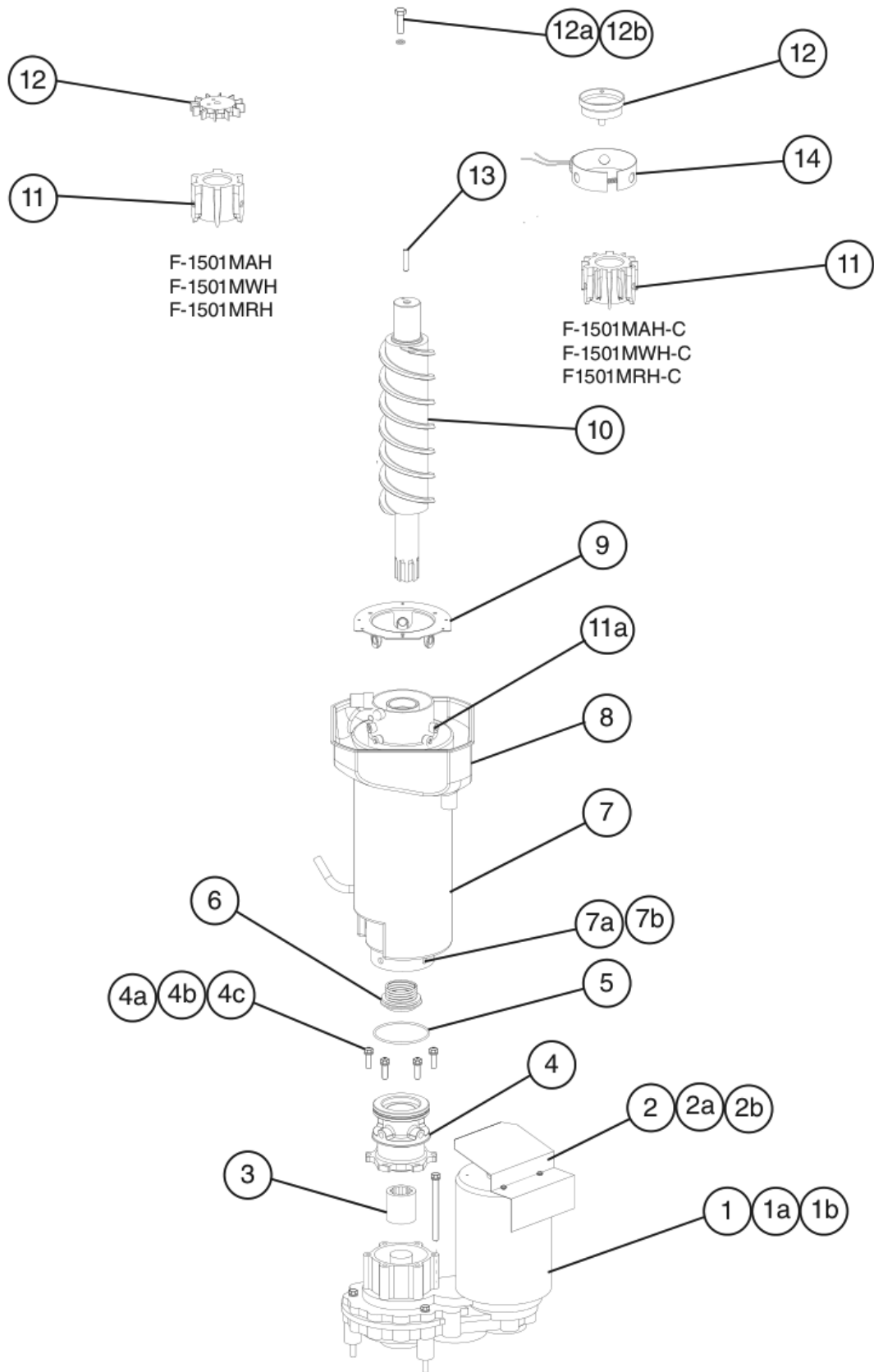

Title: B. Icemaking Unit Model: F-1501MAH(-C), F-1501MWH(-C), F-1501MRH(-C)												
Index No.	Description	Material or Model Number	Part Number	D-0 to F-0	Required Number							
1	Gear Motor		2U0129-01	1								
1a	Gear Motor Bolt		420600-02	3								
1b	Washer		7L22-1000	3								
2	Gear Motor Barrier		3A1639-01	1								
2a	Truss Head Screw	4x8, SS	7C32-0408	2								
2b	Rubber Washer		4A5268-01	2								
3	Spline Coupling		420372-01	1								
4	Housing		206509G02	1								
4a	Hex Head Bolt	8x30, SS	4A5640-01	6								
4b	Plain Washer		7W22-0800	6								
4c	Split Lock Washer		7L22-0800	6								
5	"O" Ring		4A4755-04	1								
6	Mechanical Seal		432493-01	1								
7	Evaporator		2A7005G01	1								
7a	Socket Head Cap Screw	8x12, SS	7S12-0812	4								
7b	Split Lock Washer		7L22-1000	4								
8	Drip Pan		2A6885-01	1								
9	Flange		352714-01	1								
10	Auger		120864G02	1								
11	Extruding Head	F-1501MAH F-1501MWH F-1501MRH	216407G01	1								
		F-1501MAH-C F-1501MWH-C F-1501MRH-C	264203G02	1								
11a	Seal Bolt		474757G02	3								
12	Cutter	F-1501MAH F-1501MWH F-1501MRH	327026-01	2								
		F-1501MAH-C F-1501MWH-C F-1501MRH-C	315736G01	1								
12a	Hex Head Bolt	F-1501MAH F-1501MWH F-1501MRH	7B02-1035	1								
12b	Split Lock Washer	F-1501MAH F-1501MWH F-1501MRH	7L22-1000	1								
13	Dowel Pin	F-1501MAH F-1501MWH F-1501MRH	713S-0526	1								
14	Evaporator Heater	F-1501MAH-C F-1501MWH-C F-1501MRH-C	4A4335-01	1								

C. Water Circuit
F-1501MAH(-C), F-1501MWH(-C), F-1501MRH(-C)
D-0 to F-0

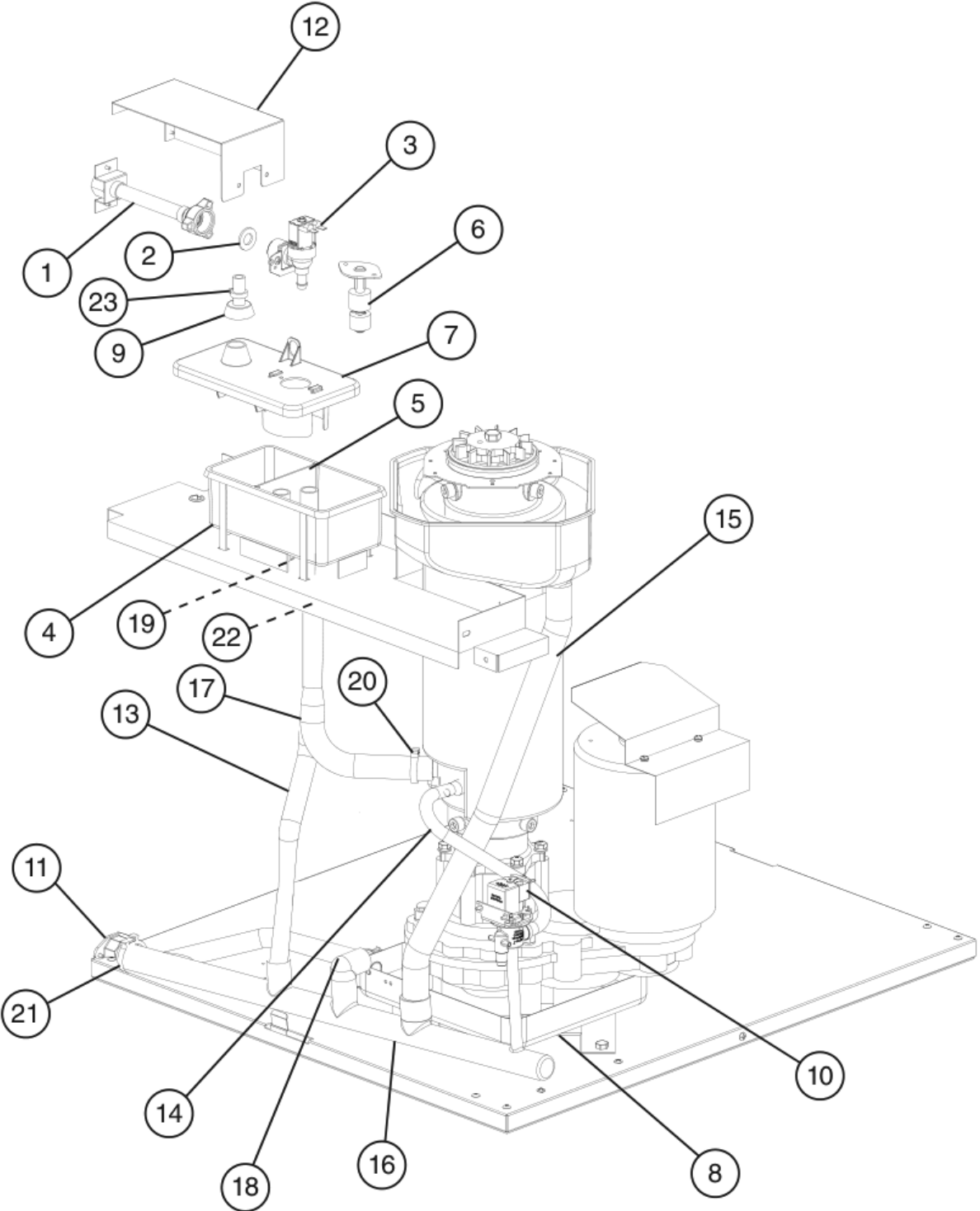

Title: C. Water Circuit Model: F-1501MAH(-C), F-1501MWH(-C), F-1501MRH(-C)

Index No.	Description	Material or Model Number	Part Number	D-0 to F-0	Required Number							
1	Water Supply Pipe		4A0891G02	1								
2	Washer		413854-03	1								
3	Inlet Water Valve		4A5309-01	1								
4	Reservoir		2A0753-01	1								
5	Reservoir Separator		4A1255-01	1								
6	Float Switch		435490-01	1								
7	Reservoir Cover		214810-01	1								
8	Drain Pan		219358G01	1								
9	Reservoir Inlet		4A0869-01	1								
10	Drain Valve		4A2772-02	1								
11	Drain Fitting		4A5528-01	1								
12	Inlet Water Valve Bracket		3A6392-01	1								
13	Vinyl Hose	L=510	7725-1923	1								
14	Silicone Hose	L=320	773013896	1								
15	Vinyl Hose	L=580	4A0658L01	1								
16	Drain Hose		3A7490-01	1								
17	Reservoir Hose		428615-04	1								
18	Elbow		4A5624-01	1								
19	Hose Clamp		4A2017-01	1								
20	Hose Clamp		4A2017-02	1								
21	Hose Clamp		4A2017-03	1								
22	Hose Clamp		4A2017-06	1								
23	Hose Clamp		4A2017-08	1								

D. Control Box Assembly
F-1501MAH(-C), F-1501MWH(-C), F-1501MRH(-C)
D-0 to F-0

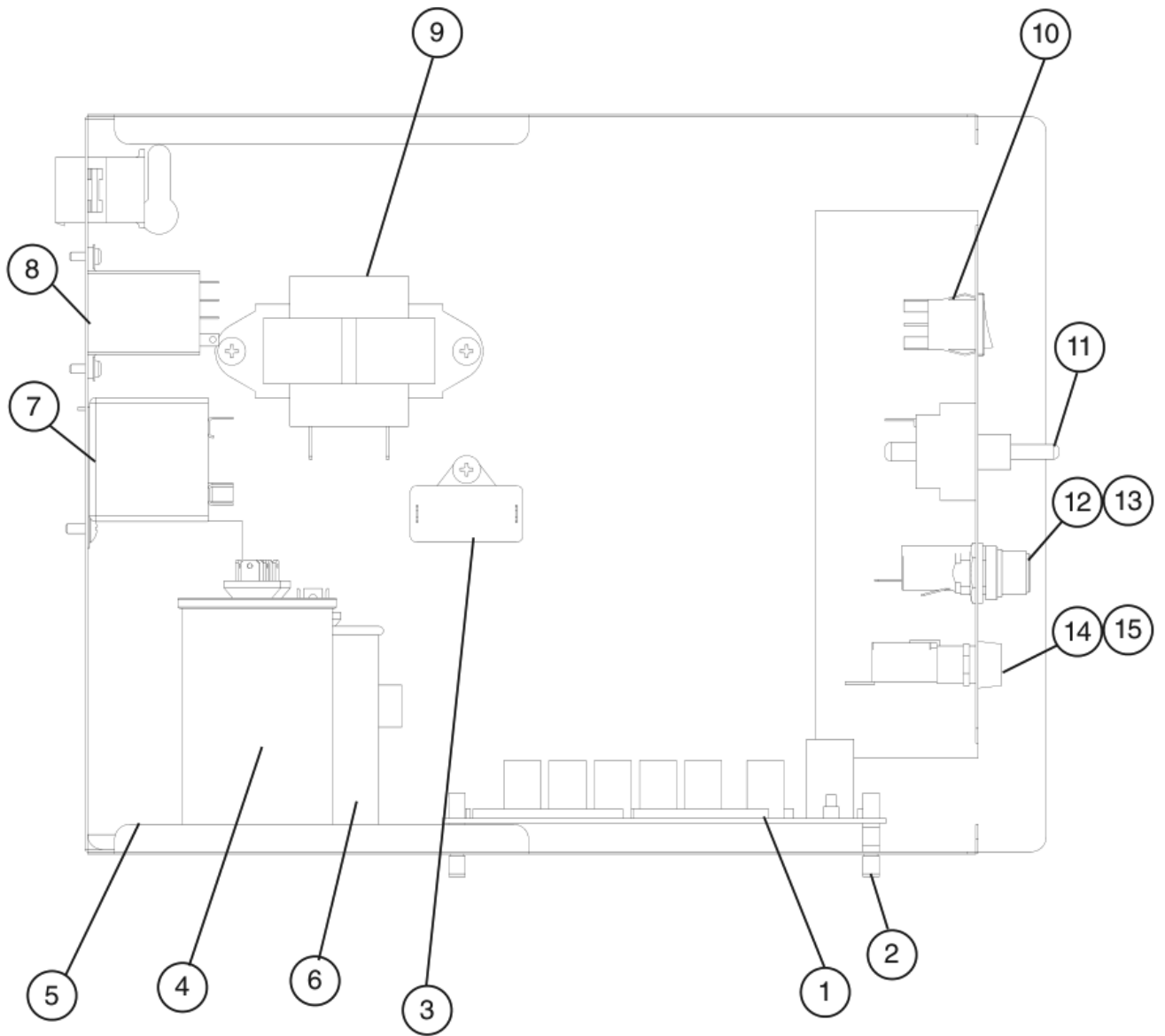

Title: D. Control Box Assembly Model: F-1501MAH(-C), F-1501MWH(-C), F-1501MRH(-C)									
Index No.	Description	Material or Model Number	Part Number	Required Number					
				D-0 (E)	D-0 (F) to F-0				
1	"F-A" Control Board		2A9093-01	1	1				
2	Control Board Support		4A0336-03	4	4				
3	Fan Motor Capacitor	F-1501MAH(-C) 5MFD, 250VAC	443192-02	1	1				
4	Gear Motor Capacitor	65MFD, 370VAC	4A5450-01	1	1				
5	Start Capacitor	145-174MFD, 220VAC	3A0076-11	1	1				
6	Run Capacitor	30MFD, 370VAC	3A2005-03	1	1				
7	Start Relay		4A1107-13	1	1				
8	Compressor Control Relay	115VAC	406132-07	1	1				
9	Control Transformer		4A0557-01	1	1				
10	Control Switch		4A0558-01	1	1				
11	Power Switch		4A2332-01	1	1				
12	Fuse Holder (Control)		4A5443-01	1	1				
13	Fuse (Control)	1A, 250VAC	4A0893-01	1	1				
14	Fuse Holder (Gear Motor)		4A3449-02	1	1				
15	Fuse (Gear Motor)	7A, 125VAC Slow Blow	4A3804-01	1	1				

E. Accessories & Labels

F-1501MAH(-C), F-1501MWH(-C), F-1501MRH(-C)

D-0 to F-0

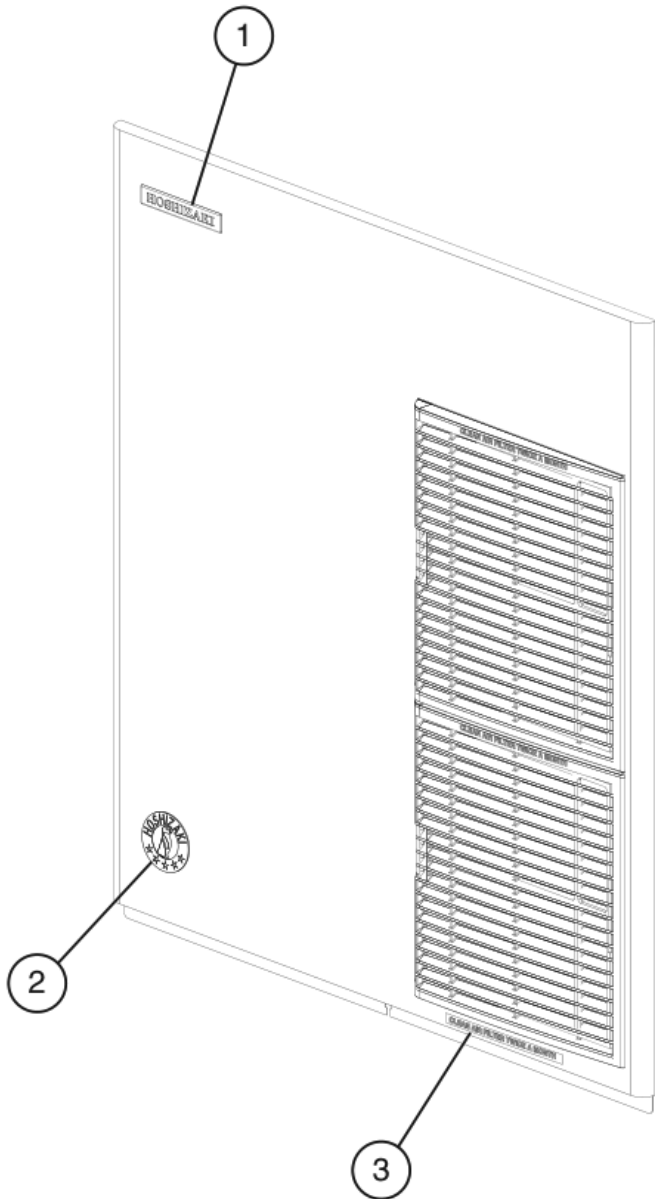

Title: E. Accessories & Labels Model: F-1501MAH(-C), F-1501MWH(-C), F-1501MRH(-C)										
Index No.	Description	Material or Model Number	Part Number	Required Number						
				D-0 to D-0 (H)	D-0 (J) to F-0					
1	Hoshizaki Emblem Label		4A0560-01	1	1					
2	Penguin Label		475552L02	1	1					
3	Air Filter Label	F-1501MAH(-C)	426177-01	1	-					
4	Universal Brace		4A0363-01	2	2					