



# HOSHIZAKI

## Parts List

### Modular Flaker

#### Models

F-822MAK(-C), MWK(-C)

F-1022MAK(-C)(-CB)(-SC)

F-1022MWK(-C)(-CB)(-SC)

F-1022MRKZ(-C)(-CB)(-SC)

F-1022MLK(-C)



## CONTENTS

Note About Ordering Parts .....	3
A. Main Assembly & Refrigeration Circuit .....	4
F-822MAK(-C) .....	4
F-1022MAK(-C)(-CB)(-SC) .....	10
F-1022MWK(-C)(-CB)(-SC) .....	13
F-1022MRKZ(-C)(-CB)(-SC) .....	16
F-1022MLK(-C) .....	19
B. Icemaking Unit .....	22
C. Water Circuit .....	24
D. Control Box Assembly .....	26
F-822M_K(-C) .....	26
F-1022M_K(Z)(-C)(-CB)(-SC) .....	27
E. Accessories & Labels .....	29

## Auxiliary Codes

**F-822MAK**

TBD

**F-822MAK-C**

Q-0 July 2025

**F-822MWK**

TBD

**F-822MWK-C**

TBD

**F-1022MAK**

TBD

**F-1022MAK-C**

TBD

**F-1022MAK-CB**

TBD

**F-1022MAK-SC**

TBD

**F-1022MWK**

TBD

**F-1022MWK-C**

TBD

**F-1022MWK-CB**

TBD

**F-1022MWK-SC**

TBD

**F-1022MRKZ**

TBD

**F-1022MRKZ-C**

Q-1 July 2025

**F-1022MRKZ-CB**

TBD

**F-1022MRKZ-SC**

TBD

**F-1022MLK**

TBD

**F-1022MLK-C**

TBD

## Auxiliary Code Breakdown

The auxiliary code is the first two characters in the serial number. The first character indicates the year. Years progress or regress in alphabetical order. The series runs from "A" through "V" and the letters "I" and "O" are skipped. The second character indicates significant part changes within a year. Base is "0" and this number advances for each change. In cases where there is a letter in parentheses, this designates the month. This is the last character in the serial number. The series runs from "(A)" through "(M)" and the letter "(I)" is skipped. This designation is only included when identifying a parts change within an auxiliary code.

## Note About Ordering Parts

Most assemblies cannot be ordered as complete units; parts in the assemblies generally must be ordered separately.

# A. Main Assembly & Refrigeration Circuit

## F-822MAK(-C)

Q-0

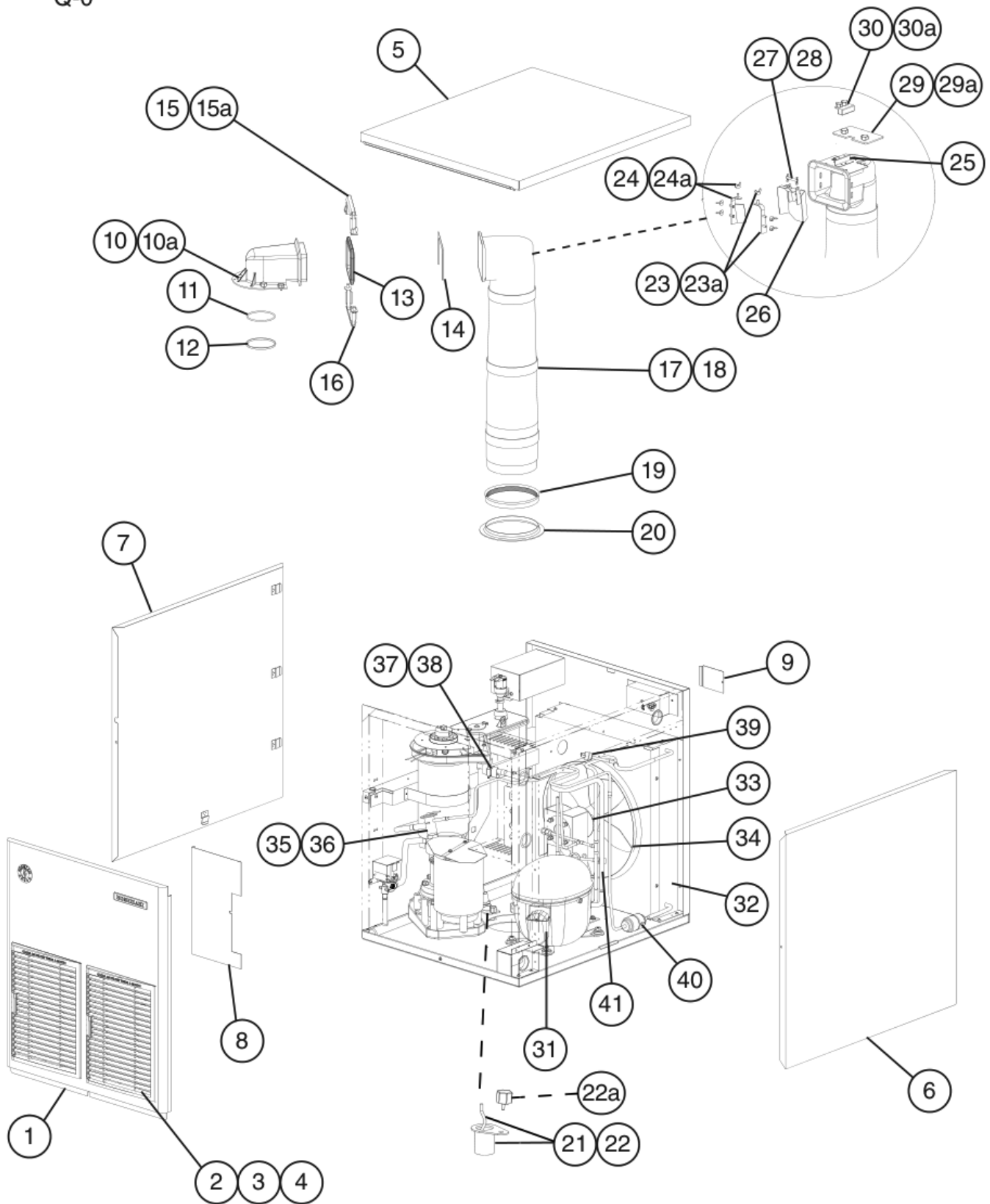

Title: A. Main Assembly & Refrigeration Circuit Model: F-822MAK(-C)												
Index No.	Description	Material or Model Number	Part Number	Required Number								
				Q-0								
<b>Main Assembly</b>												
1	Front Panel Assembly (includes item 2 and labels)		1A8332A01	1								
2	Louver Assembly (includes items 3 through 4)		2A6649A02	2								
3	Louver		1A0548-01	2								
4	Air Filter		2A2063G01	2								
5	Top Panel		2A7090-01	1								
6	Right Side Panel		2A4432G01	1								
7	Left Side Panel		2A3897G01	1								
8	Control Box Cover		3A4544-01	1								
9	Junction Box Cover		433410-01	1								
10	Spout		104797-01	1								
10a	Thumbscrew		415949G08	5								
11	O-Ring		4A4755-03	1								
12	Nylon Ring		432661-02	1								
13	Spout-to-Chute Packing		321037-01	1								
14	Spout-to-Chute Bracket		4A1712-01	1								
15	Upper Strap		328703-02	1								
15a	Wing Nut		7E12-0600	2								
16	Lower Strap		321038G02	1								
17	Chute		2A1919-01	1								
18	Chute Insulation		2A1920-01	1								
19	Chute Packing		432877-01	1								
20	Nylon Ring		3A1017-01	1								
21	Bin Control - Ultrasonic Sensor		4A6148G01	1								
22	Ultrasonic Sensor Housing		1A6270-01	1								
22a	Thumbscrew		415949G08	1								
23	Chute Baffle A		3A0400G01	1								
23a	Wing Nut		7E12-0400	3								
24	Chute Baffle B		3A0399G01	1								
24a	Wing Nut		7E12-0400	3								
25	Bin Control 2 Bracket		3A1744G01	1								
26	Actuator		436848G01	1								
27	Shaft		436851-01	1								
28	Snap Pin		715S-0005	2								
29	Plate		4A2039-01	1								
29a	Thumbscrew		415949G10	2								
30	Bin Control 2 Proximity Switch		4A2033-01	1								
30a	Thumbscrew		415949G10	2								

Title: A. Main Assembly & Refrigeration Circuit Model: F-822MAK(-C)												
Index No.	Description	Material or Model Number	Part Number	Required Number								
				Q-0								
<b>Refrigeration Circuit</b>												
31	Compressor		4A7571-01	1								
32	Condenser		2B1427-01	1								
33	Fan Motor		4A3158-01	1								
34	Fan Blade		4A0197-01	1								
35	Thermostatic Expansion Valve		4A7388-03	1								
36	Thermostatic Expansion Valve Cover		4A7233-01	1								
37	Thermostatic Expansion Valve Bulb Holder		4A7659-02	1								
38	Clamp		4A7759-01	1								
39	High-Pressure Switch		4A6039-02	1								
40	Drier		4A1113-01	1								
41	Heat Exchanger		2B1441G01	1								

**A. Main Assembly & Refrigeration Circuit**  
**F-822MWK(-C)**  
TBD

# Data Pending





**A. Main Assembly & Refrigeration Circuit**  
**F-1022MAK(-C)(-CB)(-SC)**  
TBD

# Data Pending





**A. Main Assembly & Refrigeration Circuit**  
**F-1022MWK(-C)(-CB)(-SC)**  
TBD

# Data Pending





**A. Main Assembly & Refrigeration Circuit**  
**F-1022MRKZ(-C)(-CB)(-SC)**  
 Q-1

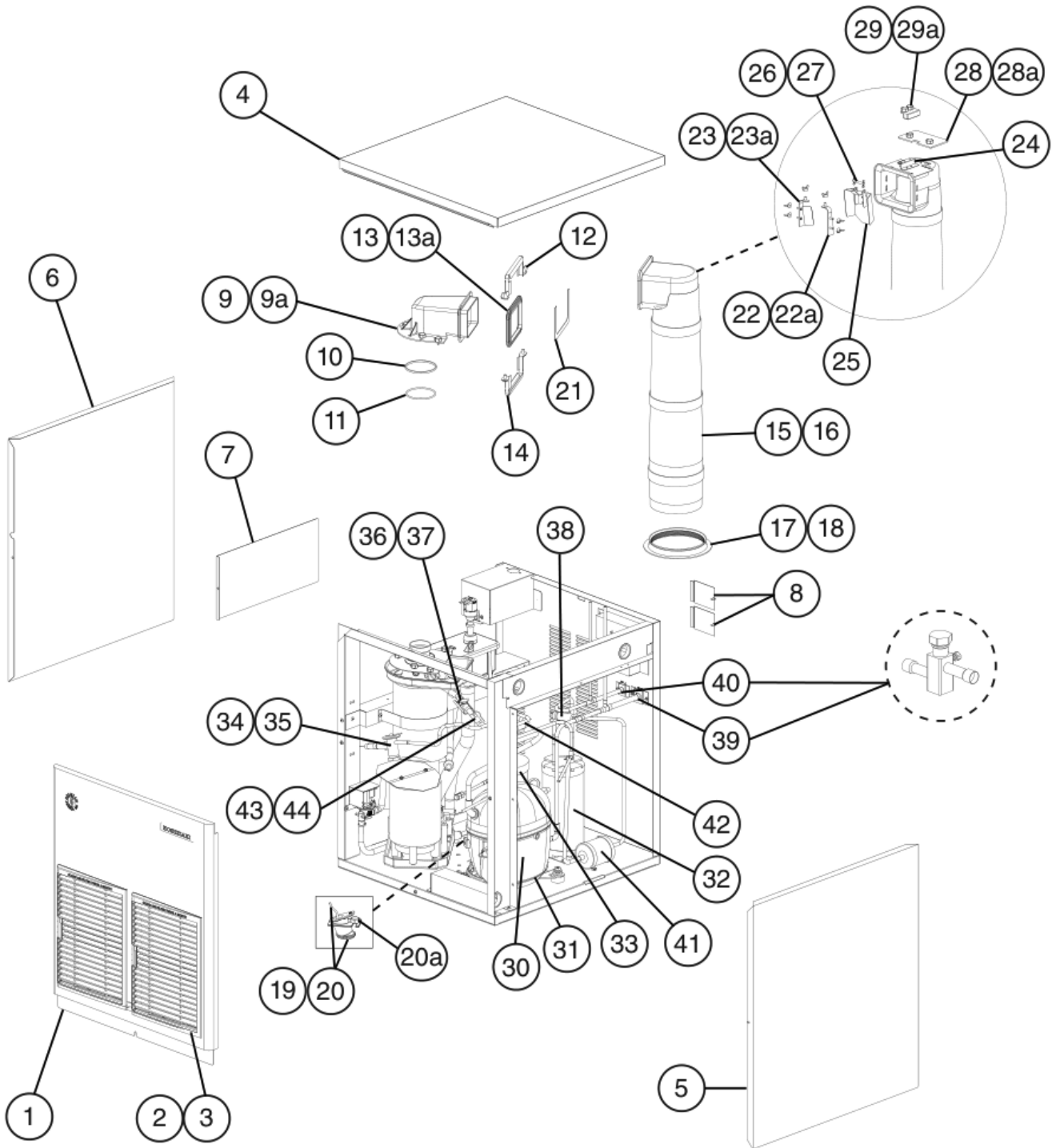

Title: A. Main Assembly & Refrigeration Circuit Model: F-1022MRKZ(-C)(-CB)(-SC)											
Index No.	Description	Material or Model Number	Part Number	Required Number							
				Q-1							
<b>Main Assembly</b>											
1	Front Panel Assembly (includes 2 each of items 2 & 3)	F-1022MRKZ(-C)(-SC)	1A6822A01	1							
		F-1022MRKZ-CB	1A6822A03	1							
2	Louver		1A0548-01	1							
3	Air Filter		2A2063G01	1							
4	Top Panel		2A7090-01	1							
5	Right Side Panel		2A4432G01	1							
6	Left Side Panel		2A3897G01	1							
7	Control Box Cover		3A4544-01	1							
8	Junction Box Cover		433410-01	2							
9	Spout		104797-01	1							
9a	Thumbscrew		415949G08	5							
10	O-Ring		4A4755-03	1							
11	Nylon Ring		432661-02	1							
12	Spout-to-Chute Packing		321037-01	1							
13	Upper Strap		328703-02	1							
13a	Wing Nut		7E12-0600	2							
14	Lower Strap		321038G02	1							
15	Chute		2A1919-01	1							
16	Chute Insulation		2A1920-01	1							
17	Chute Packing		432877-01	1							
18	Nylon Ring		3A1017-01	1							
19	Bin Control - Ultrasonic Sensor		4A6148G01	1							
20	Ultrasonic Sensor Housing		1A6270-01	1							
20a	Thumbscrew		415949G08	1							
21	Spout-to-Chute Bracket		4A1712-01	1							
22	Chute Baffle A		3A0400G01	1							
22a	Wing Nut		7E12-0400	3							
23	Chute Baffle B		3A0399G01	1							
23a	Wing Nut		7E12-0400	3							
24	Bin Control 2 Bracket (mechanical bin control)		3A1744G01	1							
25	Actuator		436848G01	1							
26	Shaft		436851-01	1							
27	Snap Pin		715S-0005	2							
28	Plate		4A2039-01	1							
28a	Thumbscrew		415949G10	2							
29	Bin Control 2 Proximity Switch (mechanical bin control)		4A2033-01	1							
29a	Thumbscrew		415949G08	2							

Title: A. Main Assembly & Refrigeration Circuit Model: F-1022MRKZ(-C)(-CB)(-SC)											
Index No.	Description	Material or Model Number	Part Number	Required Number							
				Q-1							
<b>Refrigeraton Circuit</b>											
30	Compressor		4A5669-01	1							
31	Crankcase Heater		4A5091-01	1							
32	Receiver		4A6212-01	1							
33	Accumulator		3B1322-01	1							
34	Thermostatic Expansion Valve		4A7589-01	1							
35	Thermostatic Expansion Valve Cover		4A7679-01	1							
36	Thermostatic Expansion Valve Bulb Holder		3A0107-01	2							
37	Clamp		443461-01	1							
38	High-Pressure Switch		4A7070-04	1							
39	Discharge Line Service Valve		4A3420-01	1							
40	Liquid Line Service Valve		4A3491-01	1							
41	Drier		4A1338-01	1							
42	Heat Exchanger		3B2038G01	1							
43	Thermistor		429006-05	1							
44	Thermistor Holder		427430-01	1							

**A. Main Assembly & Refrigeration Circuit**  
**F-1022MLK(-C)**  
TBD

# Data Pending





## B. Icemaking Unit

F-822M\_K(-C), F-1022M\_K(Z)(-C)(-CB)(-SC)

Q-0, Q-1

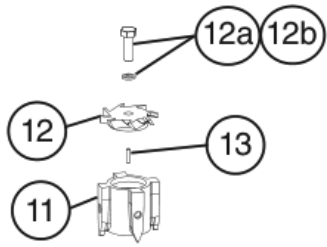

F-822M\_K, F-1022M\_K(Z)

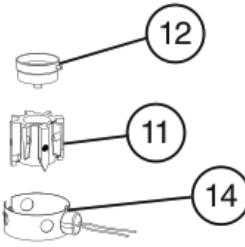

F-822M\_K-C, F-1022M\_K(Z)(-C)(-CB)

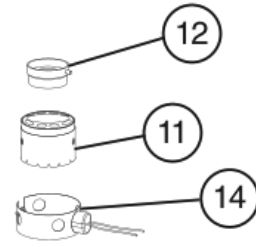

F-1022M\_K(Z)-SC

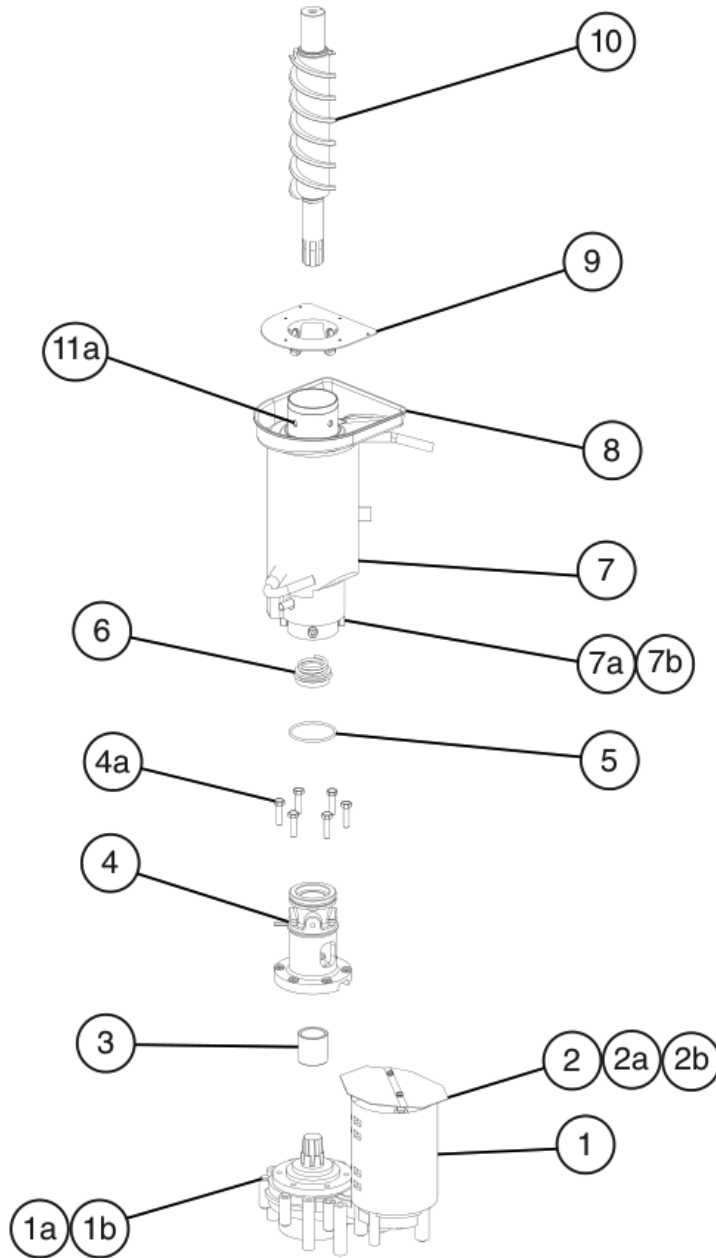

Title: B. Icemaking Unit Model: F-822M_K(-C), F-1022M_K(Z)(-C)(-CB)(-SC)											
Index No.	Description	Material or Model Number	Part Number	Required Number							
				Q-0, Q-1							
1	Gear Motor	SP-5582	4A6946-01	1							
1a	Socket Head Cap Screw	8x110, SS	7S12-0811	3							
1b	Split Lock Washer	M8	7L22-0800	3							
2	Gear Motor Barrier		3B1054-01	1							
2a	Truss Head Screw	4x8, SS	7C32-0408	2							
2b	Rubber Seal Washer	M4	4A5268-01	2							
3	Spline Coupling		414137-01	1							
4	Housing Assembly		3B0186G01	1							
4a	Hex Head Bolt	M8x30, SS	4A5640-02	6							
5	O-Ring		4A4755-02	1							
6	Mechanical Seal		432492-03	1							
7	Evaporator		2A7209G01	1							
7a	Socket Head Cap Screw	8x12, SS	4A7498-02	4							
7b	Split Lock Washer	M8	7L22-0800	4							
8	Drip Pan		2A7187-01	1							
9	Flange		352713-01	1							
10	Auger		2B0533G02	1							
11	Extruding Head	F-822M_K F-1022M_K(Z)	3A2175G01	1							
		F-822M_K-C F-1022M_K(Z) (-C)(-CB)	3A2176G01	1							
		F-1022M_K(Z) (-SC)	3A9761G02	1							
11a	Seal Bolt	M8	P01768-02	4							
		F-1022M_K(Z) (-SC)	4A6172A02	4							
12	Cutter	F-822M_K F-1022M_K(Z)	3A1395-02	1							
		F-822M_K-C F-1022M_K(Z) (-C)(-CB)	427183G01	1							
		F-1022M_K(Z) (-SC)	4A6209G01	1							
12a	Hex Head Bolt	10x30 F-822M_K F-1022M_K(Z)	7B02-1030	1							
12b	Split Lock Washer	M8 F-822M_K F-1022M_K(Z)	7L22-0800	1							
13	Dowel Pin	4x16 F-822M_K F-1022M_K(Z)	713S-0416	1							
14	Evaporator Heater	F-822M_K-C F-1022M_K(Z) (-C)(-CB)(-SC)	4A2292-01	1							

**C. Water Circuit**  
**F-822M\_K(-C), F-1022M\_K(Z)(-C)(-CB)(-SC)**  
 Q-0, Q-1

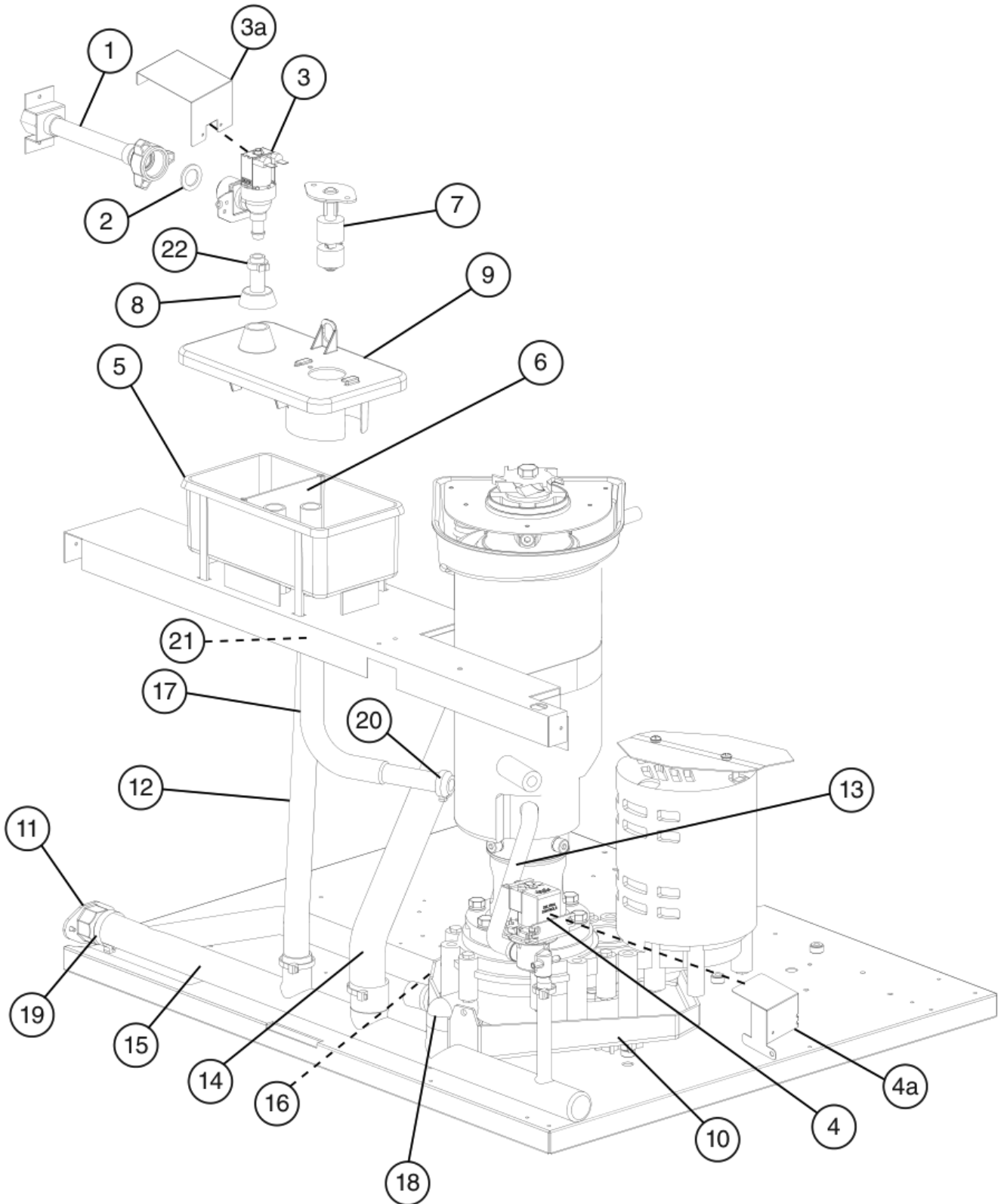

Title: C. Water Circuit Model: F-822M_K(-C), F-1022M_K(Z)(-C)(-CB)(-SC)									
Index No.	Description	Material or Model Number	Part Number	Required Number					
				Q-0,					
1	Water Supply Pipe		4A7116G01	1					
2	Rubber Gasket		413854-03	1					
3	Inlet Water Valve		4A5309-01	1					
3a	Inlet Water Valve Bracket	F-822M_K(-C)	3B2172-01	1					
		F-1022M_K(Z)(-C)(-CB)(SC)	3B2023-01	1					
4	Drain Valve		4A2772-02	1					
4a	Drain Valve Bracket		3A7922-01	1					
5	Reservoir		2A0753-01	1					
6	Reservoir Separator		4A1255-01	1					
7	Float Switch		435490-01	1					
8	Reservoir Inlet		4A0869-01	1					
9	Reservoir Cover		214810-01	1					
10	Drain Pan		323765G02	1					
11	Drain Fitting		4A5528-01	1					
12	Vinyl Hose	L=405 mm	7725B1923	1					
13	Silicone Hose	L=185 mm	7730I3896	1					
14	Vinyl Hose	L=460 mm	4A0658L01	1					
15	Drain Hose		3A8198-02	1					
16	Vinyl Hose	L=30 mm	7725B1923	1					
17	Reservoir Hose		4A1165-06	1					
18	Elbow		4A5624-01	1					
<b>Clamps</b>									
19	Hose Clamp	26-30 mm	4A2017-02	1					
20	Hose Clamp	17-20 mm	4A2017-05	1					
21	Hose Clamp	19-22 mm	4A2017-06	1					
22	Hose Clamp	14-15 mm	4A2017-08	1					

**D. Control Box Assembly**  
**F-822M\_K(-C)**  
1/2  
Q-0

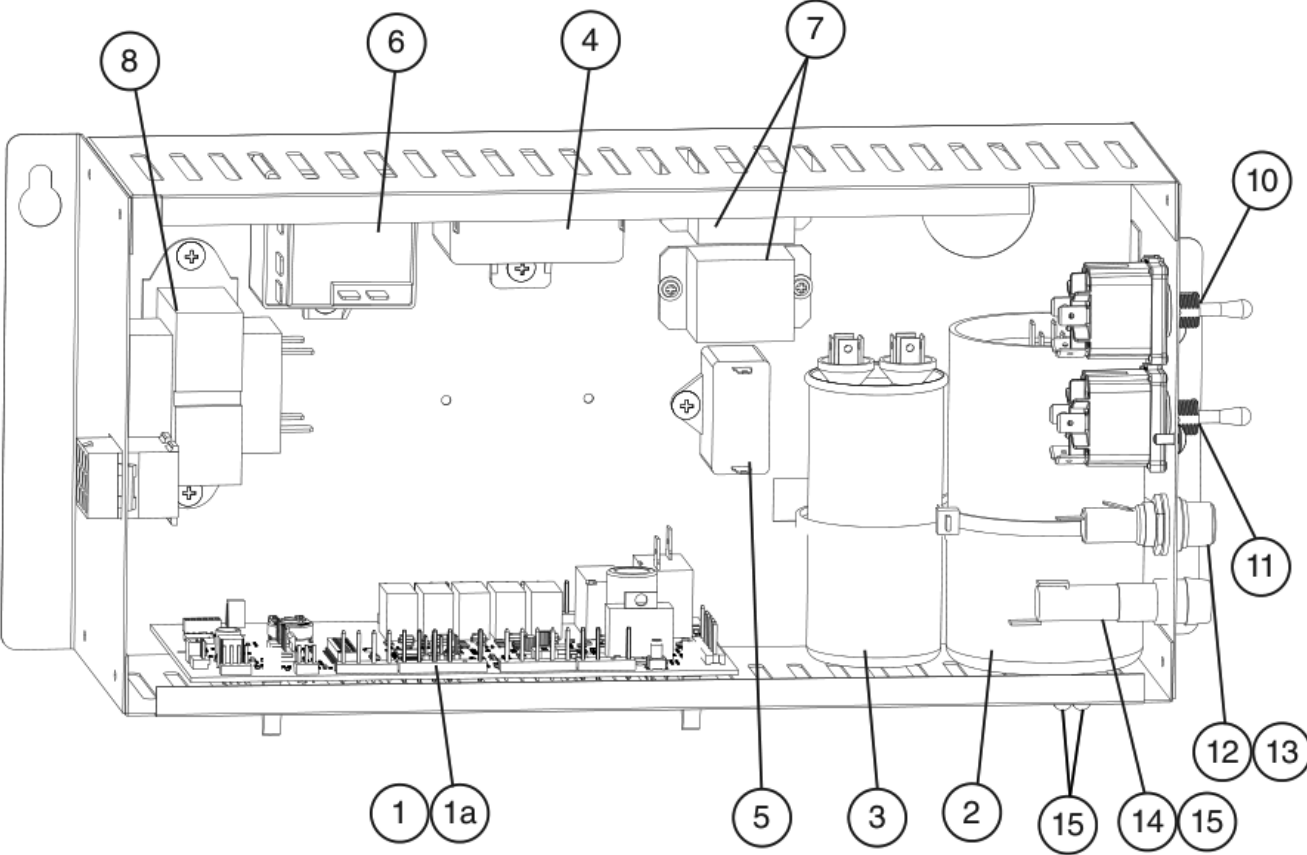

**D. Control Box Assembly**  
**F-1022M\_K(Z)(-C)(-CB)(-SC)**  
**2/2**  
Q-1

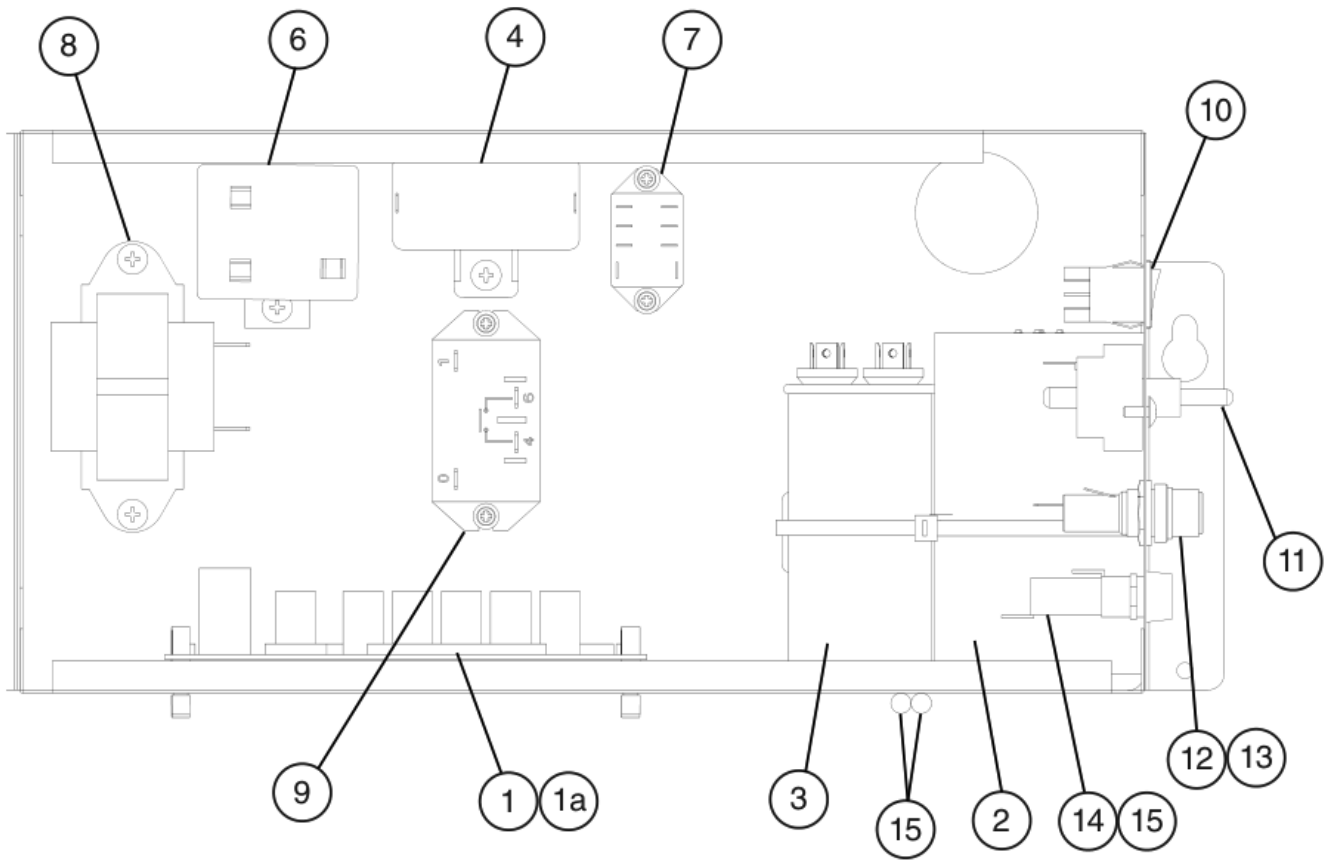

<b>Title: D. Control Box Assembly</b>		<b>Model: F-822M_K(-C), F-1022M_K(Z)(-C)(-CB)(-SC)</b>										
Index No.	Description	Material or Model Number	Part Number	Required Number								
				Q-0,								
1	Control Board	<b>F-822M_K(-C)</b>	<a href="#">2A9874-03</a>	1								
		<b>F-1022M_K(Z)(-C)(-CB)(-SC)</b>	<a href="#">2A9874-02</a>	1								
1a	Control Board Support		<a href="#">4A0336-03</a>	4								
2	Start Capacitor	243-292MFD, 165VAC <b>F-822M_K(-C)</b>	<a href="#">3A0076-20</a>	1								
		340-408MFD, 250VAC <b>F-1022M_K(Z)(-C)(-CB)(-SC)</b>	<a href="#">3A0076-24</a>	1								
3	Run Capacitor	243-292MFD, 165VAC <b>F-822M_K(-C)</b>	<a href="#">3A2005-14</a>	1								
		40MFD, 370VAC <b>F-1022M_K(Z)(-C)(-CB)(-SC)</b>	<a href="#">3A2005-13</a>	1								
4	Gear Motor Capacitor	24MFD, 250VAC	<a href="#">4A2273-01</a>	1								
5	Fan Motor Capacitor	5MFD, 250VAC <b>F-822MAK(-C)</b>	<a href="#">4A6435-02</a>	1								
6	Start Relay	<b>F-822M_K(-C)</b>	<a href="#">4A7587-01</a>	1								
		<b>F-1022M_K(Z)(-C)(-CB)(-SC)</b>	<a href="#">4A1107-22</a>	1								
7	Compressor Control Relay	120VAC <b>F-822M_K(-C)</b>	<a href="#">4A7047-03</a>	2								
		<b>F-1022M_K(Z)(-C)(-CB)(-SC)</b>	<a href="#">4A6558-01</a>	1								
8	Control Transformer		<a href="#">4A0557-01</a>	1								
9	Compressor Relay	<b>F-1022M_K(Z)(-C)(-CB)(-SC)</b>	<a href="#">4A3140-01</a>	1								
10	Control Switch	<b>F-822M_K(-C)</b>	<a href="#">4A7449-02</a>	1								
		<b>F-1022M_K(Z)(-C)(-CB)(-SC)</b>	<a href="#">4A0558-01</a>	1								
11	Power Switch	<b>F-822M_K(-C)</b>	<a href="#">4A7449-02</a>	1								
		<b>F-1022M_K(Z)(-C)(-CB)(-SC)</b>	<a href="#">4A2332-01</a>	1								
12	Fuse Holder (Control)		<a href="#">4A5443-01</a>	1								
13	Fuse (Control)	AGC-1A, 250VAC	<a href="#">4A0893-01</a>	1								
14	Fuse Holder (Gear Motor)		<a href="#">4A6101-01</a>	1								
15	Fuse (Gear Motor)	GMD-3A, 250VAC Slow Blow	<a href="#">4A0893-06</a>	3								

## E. Accessories & Labels

F-822M\_K(-C), F-1022M\_K(Z)(-C)(-CB)(-SC)

Q-0, Q-1

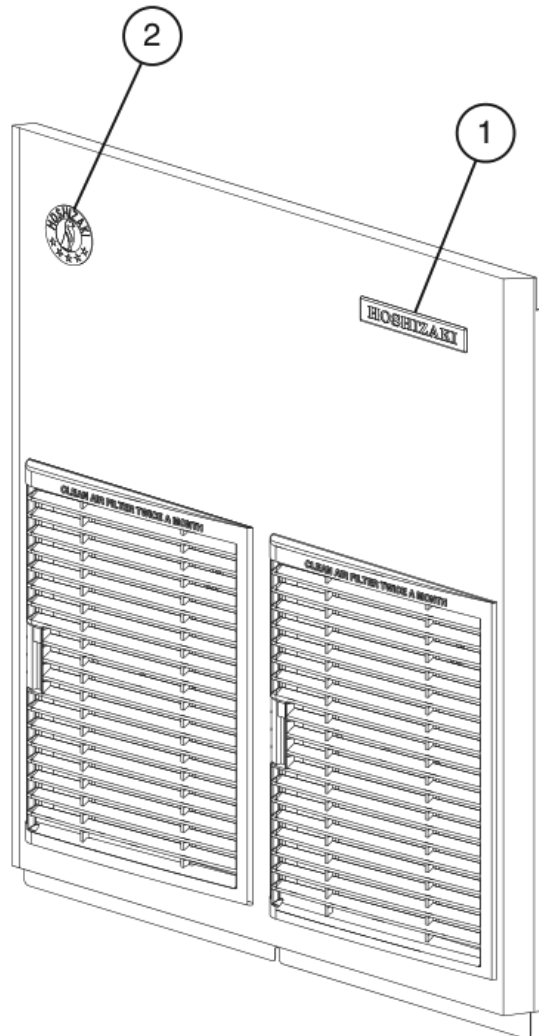

Title: E. Accessories & Labels    Model: F-822M_K(-C), F-1022M_K(Z)(-C)(-CB)(-SC)																	
Index No.	Description	Material or Model Number	Part Number	Required Number													
				Q-0,													
1	Hoshizaki Emblem Label		4A0560-01	1													
2	Penguin Label		475552L02	1													
3	Universal Brace		4A0363-01	2													
3a	Hex Bolt		7B02-0512	4													