



# HOSHIZAKI

## Parts List

Modular Flaker

Models

FD-1002MAJ-C, MAJ-CB,

FD-1002MRJ-C, MRJ-CB,

FD-1002MRJZ-C, MRJZ-CB



[hoshizakiamerica.com](http://hoshizakiamerica.com)

Number: 71372  
Issued: 8-14-2017  
Revised: 7-24-2024

## CONTENTS

Note About Ordering Parts .....	3
A. Main Assembly & Refrigeration Circuit .....	4
FD-1002MAJ-C, FD-1002MAJ-CB .....	4
FD-1002MRJ(Z)-C, FD-1002MRJ(Z)-CB .....	7
B. Icemaking Unit.....	10
C. Water Circuit.....	12
D. Control Box Assembly.....	14
E. Accessories & Labels .....	16

## Auxiliary Codes

### FD-1002MAJ-C

F-0 August 2016  
G-0 January 2017  
G-1 April 2017  
H-0 January 2018  
J-0 January 2019  
J-1 April 2019  
J-2 July 2019  
J-3 September 2019  
K-0 January 2020  
L-0 January 2021  
L-1 June 2021  
L-2 November 2021  
M-0 January 2022  
M-1 May 2022  
M-2 October 2022  
N-0 January 2023  
N-3 October 2023  
P-0 January 2024

### FD-1002MAJ-CB

M-1 May 2022  
M-2 December 2022  
N-0 March 2023  
N-3 October 2023  
P-0 January 2024

### FD-1002MRJ-C

F-0 August 2016  
G-0 January 2017  
G-1 April 2017  
F-0 August 2016  
G-0 January 2017  
G-1 April 2017  
H-0 January 2018  
J-0 February 2019  
J-1 April 2019  
J-2 July 2019  
J-3 September 2019  
K-0 January 2020  
L-0 January 2021  
L-1 August 2021

### FD-1002MRJ-CB

K-0 May 2020  
L-0 January 2021  
L-1 August 2021

### FD-1002MRJZ-C

L-0 October 2021  
L-1 December 2021  
M-0 February 2022  
M-1 May 2022  
M-2 June 2022  
N-0 January 2023  
P-0 January 2024

### FD-1002MRJZ-CB

L-0 August 2021  
L-1 November 2021  
M-0 February 2022  
M-1 May 2022  
M-2 June 2022  
N-0 January 2023  
N-3 October 2023  
P-0 January 2024

## Auxiliary Code Breakdown

The auxiliary code is the first two characters in the serial number. The first character indicates the year. Years progress or regress in alphabetical order. The series runs from "A" through "V" and the letters "I" and "O" are skipped. The second character indicates significant part changes within a year. Base is "0" and this number advances for each change. In cases where there is a letter in parentheses, this designates the month. This is the last character in the serial number. The series runs from "(A)" through "(M)" and the letter "(I)" is skipped. This designation is only included when identifying a parts change within an auxiliary code.

## Note About Ordering Parts

Most assemblies cannot be ordered as complete units; parts in the assemblies generally must be ordered separately.

**A. Main Assembly & Refrigeration Circuit**  
**FD-1002MAJ-C, FD-1002MAJ-CB**

1/2

F-0 to N-2

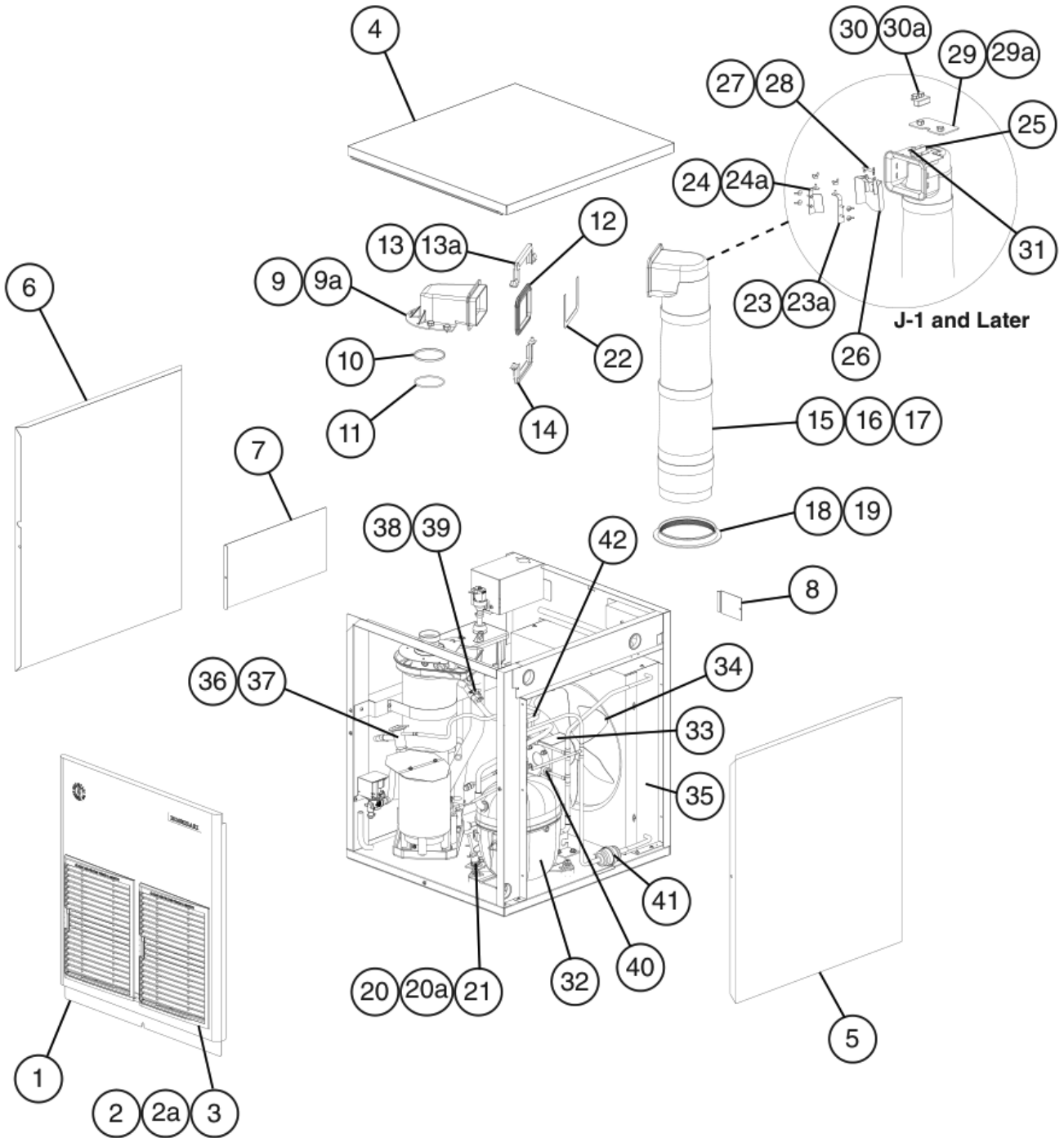

# A. Main Assembly & Refrigeration Circuit

## FD-1002MAJ-C, FD-1002MAJ-CB

2/2

N-3, P-0

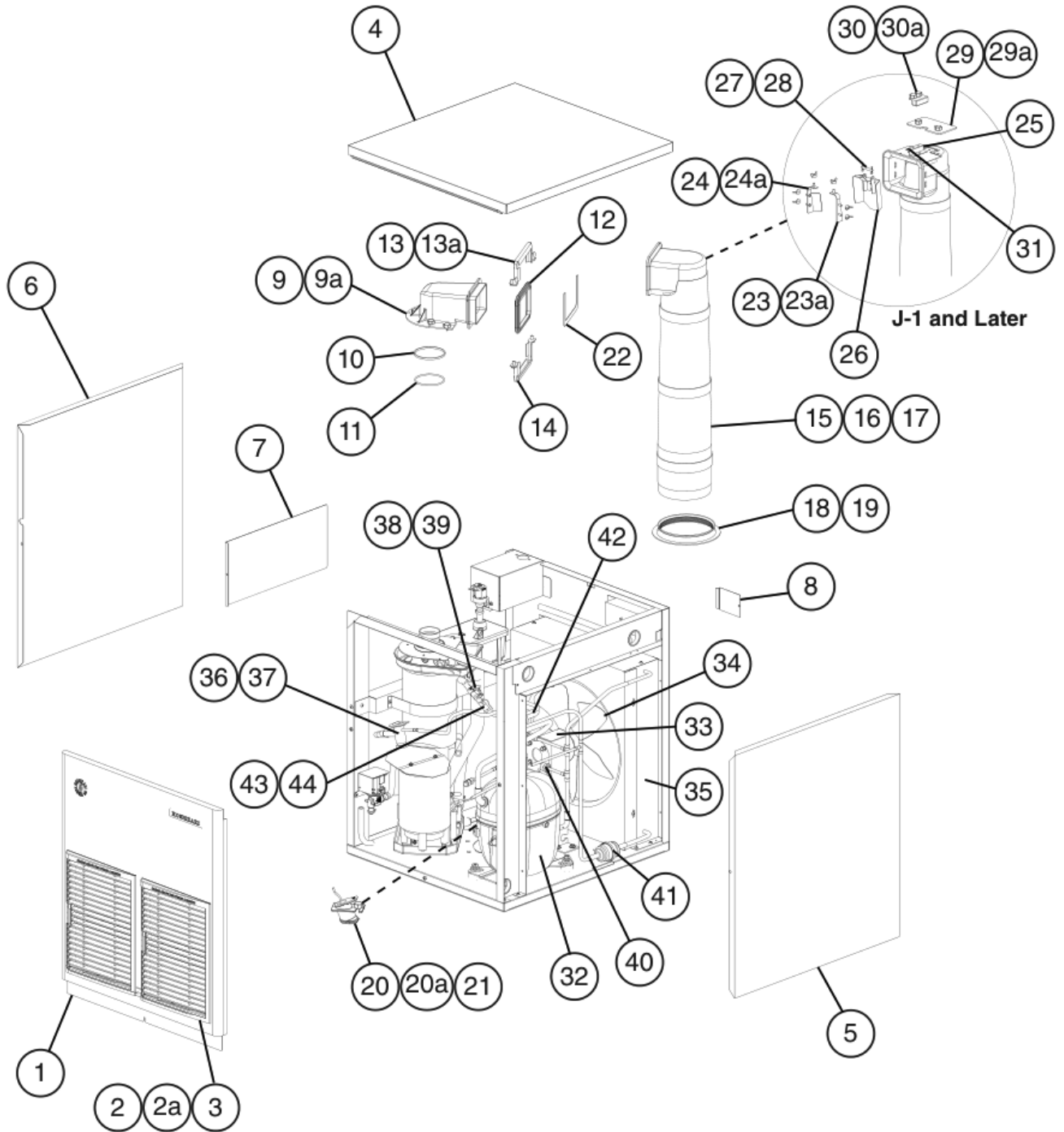

Title: A. Main Assembly & Refrigeration Circuit Model: FD-1002MAJ-C, FD-1002MAJ-CB											
Index No.	Description	Material or Model Number	Part Number	Required Number							
				F-0 to G-0	G-1 H-0	J-0	J-1 to M-0	M-1 to N-2	N-3 P-0		
<b>Main Assembly</b>											
1	Front Panel Assembly (includes 2 each of items 2 & 3)	FD-1002MAJ-C	3B1080G01	1	1	1	1	1	1		
		FD-1002MAJ-CB	1A6090A01					1	1		
2	Louver		1A0548-01	2	2	2	2	2	2		
2a	Push Retainer		4A2414-01	6	6	-					
3	Air Filter		2A2063G01	2	2	2	2	2	2		
4	Top Panel		2A7090-01	1	1	1	1	1	1		
5	Right Side Panel		2A4432G01	1	1	1	1	1	1		
6	Left Side Panel		2A3897G01	1	1	1	1	1	1		
7	Control Box Cover		3A4544-01	1	1	1	1	1	1		
8	Junction Box Cover		433410-01	1	1	1	1	1	1		
9	Spout		104797-01	1	1	1	1	1	1		
9a	Thumbscrew		415949G08	5	5	5	5	5	5		
10	O-Ring		4A4755-03	1	1	1	1	1	1		
11	Nylon Ring		432661-02	1	1	1	1	1	1		
12	Spout-to-Chute Packing		321037-01	1	1	1	1	1	1		
13	Upper Strap		328703-02	1	1	1	1	1	1		
13a	Wing Nut		7E12-0600	2	2	2	2	2	2		
14	Lower Strap		321038G02	1	1	1	1	1	1		
15	Chute		2A1919-03	1	1	1	-				
			2A1919-01				1	1	1		
16	Chute Insulation		2A1920-01	1	1	1	1	1	1		
17	Chute Tie		436531G01	3	-						
18	Chute Packing		432877-01	1	1	1	1	1	1		
19	Ring		3A1017-01	1	1	1	1	1	1		
20	Bin Control 1 Housing (infrared sensor)		3A3478-01	1	1	1	1	1	-		
	Bin Control 1 Housing (ultrasonic sensor)		1A6270-01						1		
20a	Thumbscrew		415949G08	1	1	1	1	1	1		
21	Bin Control 1 (infrared sensor)		4A4469-01	1	1	1	1	1	-		
	Bin Control 1 (ultrasonic sensor)		4A6148G01						1		
22	Spout-to-Chute Bracket		4A1712-01	1	1	1	1	1	1		
23	Chute Baffle A		3A0400G01				1	1	1		
23a	Wing Nut		7E12-0400				3	3	3		
24	Chute Baffle B		3A0399G01				1	1	1		
24a	Wing Nut		7E12-0400				3	3	3		
25	Bin Control 2 Bracket (mechanical bin control)		3A1744G01				1	1	1		
26	Actuator		436848G01				1	1	1		
27	Shaft		436851-01				1	1	1		
28	Snap Pin		715S-0005				2	2	2		
29	Plate		4A2039-01				1	1	1		
29a	Thumbscrew		415949G10				2	2	2		
30	Bin Control 2 Proximity Switch (mechanical bin control)		4A2033-01				1	1	1		
30a	Thumbscrew		415949G08				2	2	2		
31	Truss Head Screw (ground)		7C32-0408				1	1	1		

Title: A. Main Assembly & Refrigeration Circuit Model: FD-1002MAJ-C, FD-1002MAJ-CB												
Index No.	Description	Material or Model Number	Part Number	Required Number								
				F-0 to G-0	G-1 H-0	J-0	J-1 to M-0	M-1 to N-2	N-3 P-0			
<b>Refrigeraton Circuit</b>												
32	Compressor		4A5669-01	1	1	1	1	1	1	1		
33	Fan Motor		4A3158-01	1	1	1	1	1	1	1		
34	Fan Blade		4A0197-01	1	1	1	1	1	1	1		
35	Condenser		211663-02	1	1	1	1	1	1	1		
36	Thermostatic Expansion Valve		4A1117-01	1	1	1	-					
			4A3493-01				1	1	1			
37	Thermostatic Expansion Valve Cover		4A1168-01	1	1	1	1	1	1	1		
38	Thermostatic Expansion Valve Bulb Holder		3A0112-01	1	1	1	1	1	1	1		
39	Clamp		443461-01	1	1	1	1	1	1	1		
40	High-Pressure Switch		4A7070-04	1	1	1	1	1	1	1		
41	Drier		4A2666-01	1	1	1	1	1	1	1		
42	Heat Exchanger		3A7904G01	1	1	1	1	1	1	1		
43	Thermistor		429006-05							1		
44	Thermistor Holder		427430-01							1		

**A. Main Assembly & Refrigeration Circuit**  
**FD-1002MRJ(Z)-C, FD-1002MRJ(Z)-CB**  
 1/2  
 F-0 to N-2

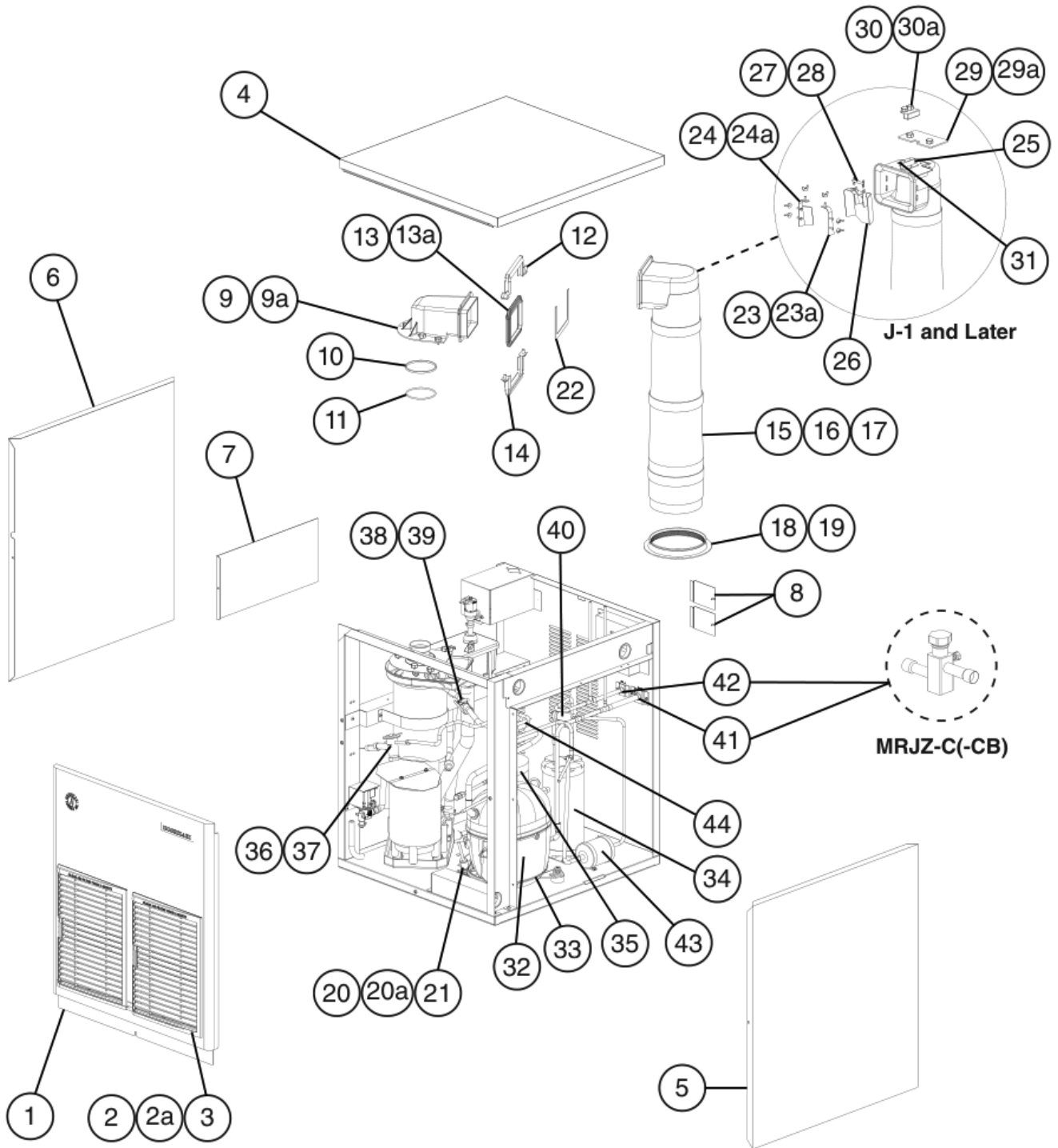

**A. Main Assembly & Refrigeration Circuit**  
**FD-1002MRJ(Z)-C, FD-1002MRJ(Z)-CB**  
 2/2  
 N-3, P-0

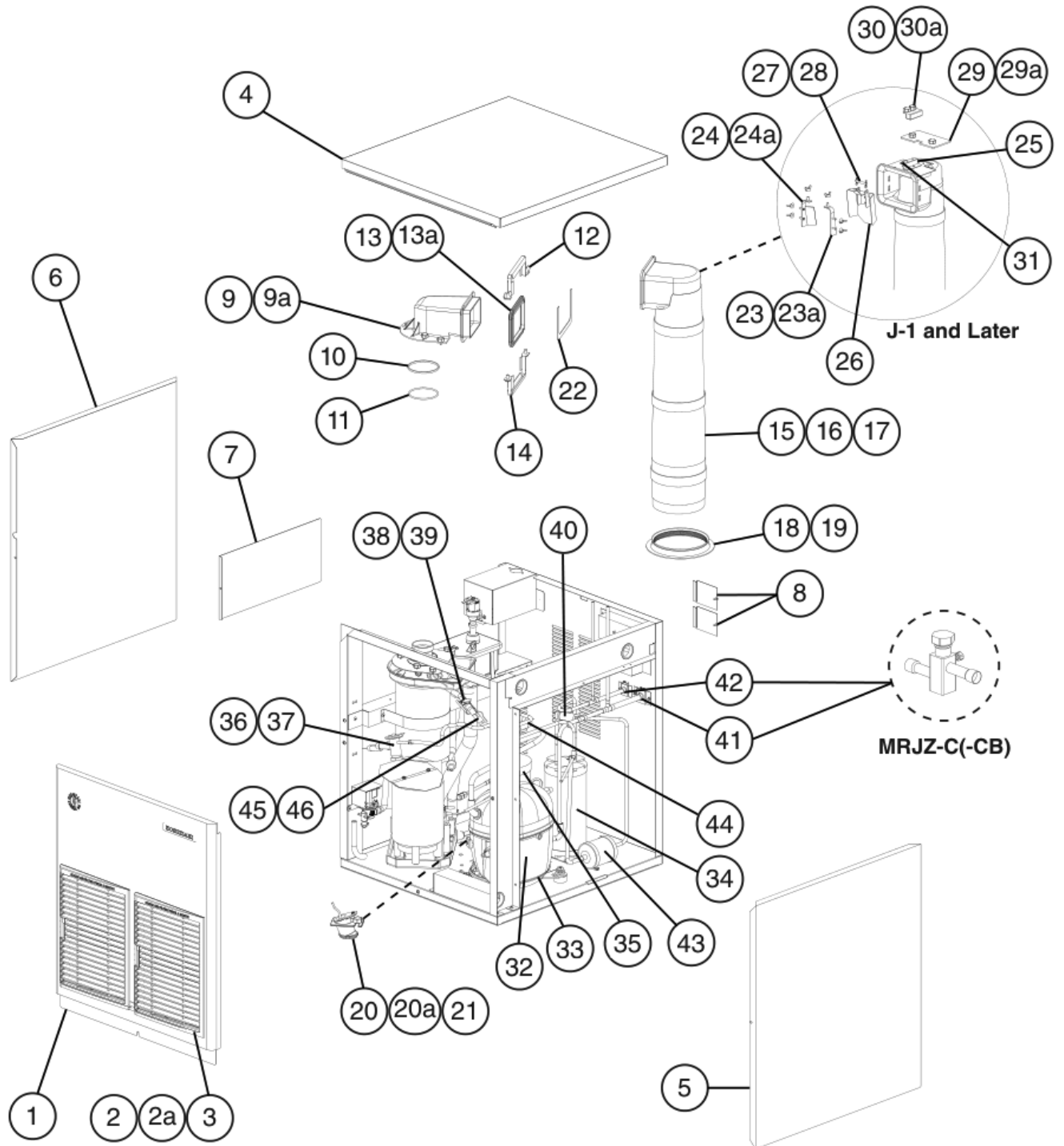

Title: A. Main Assembly & Refrigeration Circuit Model: FD-1002MRJ(Z)-C, FD-1002MRJ(Z)-CB												
Index No.	Description	Material or Model Number	Part Number	Required Number								
				F-0 to G-0	G-1 to J-0	J-1 to J-2	J-3	K-0 to L-0	M-1	M-2 to N-2	N-3 to P-0	
<b>Main Assembly</b>												
1	Front Panel Assembly (includes 2 each of items 2 & 3)	FD-1002MRJ(Z)-C	3B1080G01	1	1	1	1	1	1	1	1	1
		FD-1002MRJ(Z)-CB	1A6090A01					1	1	1	1	
2	Louver		1A0548-01	1	1	1	1	1	1	1	1	1
2a	Push Retainer		4A2414-01	6	-							
3	Air Filter		2A2063G01	1	1	1	1	1	1	1	1	1
4	Top Panel		2A7090-01	1	1	1	1	1	1	1	1	1
5	Right Side Panel		2A4432G01	1	1	1	1	1	1	1	1	1
6	Left Side Panel		2A3897G01	1	1	1	1	1	1	1	1	1
7	Control Box Cover		3A4544-01	1	1	1	1	1	1	1	1	1
8	Junction Box Cover		433410-01	2	2	2	2	2	2	2	2	2
9	Spout		104797-01	1	1	1	1	1	1	1	1	1
9a	Thumbscrew		415949G08	5	5	5	5	5	5	5	5	5
10	O-Ring		4A4755-03	1	1	1	1	1	1	1	1	1
11	Nylon Ring		432661-02	1	1	1	1	1	1	1	1	1
12	Spout-to-Chute Packing		321037-01	1	1	1	1	1	1	1	1	1
13	Upper Strap		328703-02	1	1	1	1	1	1	1	1	1
13a	Wing Nut		7E12-0600	2	2	2	2	2	2	2	2	2
14	Lower Strap		321038G02	1	1	1	1	1	1	1	1	1
15	Chute		2A1919-03	1	1	-						
			2A1919-01			1	1	1	1	1	1	1
16	Chute Insulation		2A1920-01	1	1	1	1	1	1	1	1	1
17	Chute Tie		436531G01	3	-							
18	Packing		432877-01	1	1	1	1	1	1	1	1	1
19	Nylon Ring		3A1017-01	1	1	1	1	1	1	1	1	1
20	Bin Control 1 Housing (infrared sensor)		3A3478-01	1	1	1	1	1	1	1	1	-
	Bin Control 1 Housing (ultrasonic sensor)		1A6270-01									1
20a	Thumbscrew		415949G08	1	1	1	1	1	1	1	1	1
21	Bin Control 1 (infrared sensor)		4A4469-01	1	1	1	1	1	1	1	1	-
	Bin Control 1 (ultrasonic sensor)		4A6148G01									1
22	Spout-to-Chute Bracket		4A1712-01	1	1	1	1	1	1	1	1	1
23	Chute Baffle A		3A0400G01			1	1	1	1	1	1	1
23a	Wing Nut		7E12-0400			3	3	3	3	3	3	3
24	Chute Baffle B		3A0399G01			1	1	1	1	1	1	1
24a	Wing Nut		7E12-0400			3	3	3	3	3	3	3
25	Bin Control 2 Bracket (mechanical bin control)		3A1744G01			1	1	1	1	1	1	1
26	Actuator		436848G01			1	1	1	1	1	1	1
27	Shaft		436851-01			1	1	1	1	1	1	1
28	Snap Pin		715S-0005			2	2	2	2	2	2	2
29	Plate		4A2039-01			1	1	1	1	1	1	1
29a	Thumbscrew		415949G10			2	2	2	2	2	2	2
30	Bin Control 2 Proximity Switch (mechanical bin control)		4A2033-01			1	1	1	1	1	1	1
30a	Thumbscrew		415949G08			2	2	2	2	2	2	2
31	Truss Head Screw (ground)		7C32-0408			1	1	1	1	1	1	1

Title: A. Main Assembly & Refrigeration Circuit Model: FD-1002MRJ(Z)-C, FD-1002MRJ(Z)-CB												
Index No.	Description	Material or Model Number	Part Number	Required Number								
				F-0 to G-0	G-1 to J-0	J-1 to J-2	J-3	K-0 to L-0	M-1	M-2 to N-2	N-3 to P-0	
<b>Refrigeraton Circuit</b>												
32	Compressor		4A5669-01	1	1	1	1	1	1	1	1	
33	Crankcase Heater		4A5091-01	1	1	1	1	1	1	1	1	
34	Receiver		437596-01	1	1	1	1	1	1	1	1	
35	Accumulator		3A4276-01				1	1	1	-		
			3B1322-01							1	1	
36	Thermostatic Expansion Valve		4A3493-01	1	1	1	1	1	1	1	1	
37	Thermostatic Expansion Valve Cover		4A1168-01	1	1	1	1	1	1	1	1	
38	Thermostatic Expansion Valve Bulb Holder		3A0112-01	1	1	1	1	1	1	1	1	
39	Clamp		443461-01	1	1	1	1	1	1	1	1	
40	High-Pressure Switch		4A7070-04	1	1	1	1	1	1	1	1	
41	Discharge Line Coupling	FD-1002MRJ-C FD-1002MRJ-SC	434072-01	1	1	1	1	1	-			
	Discharge Line Service Valve	FD-1002MRJZ-C FD-1002MRJZ-SC	4A3491-01							1	1	1
42	Liquid Line Coupling	FD-1002MRJ-C FD-1002MRJ-SC	426554-01	1	1	1	1	1	-			
	Liquid Line Service Valve	FD-1002MRJZ-C FD-1002MRJZ-SC	4A3491-01							1	1	1
43	Drier		4A1338-01	1	1	1	1	1	1	1	1	
44	Heat Exchanger		3A7904G01	1	1	1	-					
			3B0348G01				1	1	1	1	1	
45	Thermistor		429006-05									1
46	Thermistor Holder		427430-01									1

**B. Icemaking Unit**  
**FD-1002M\_J(Z)(-C)(-CB)**  
F-0 to P-0

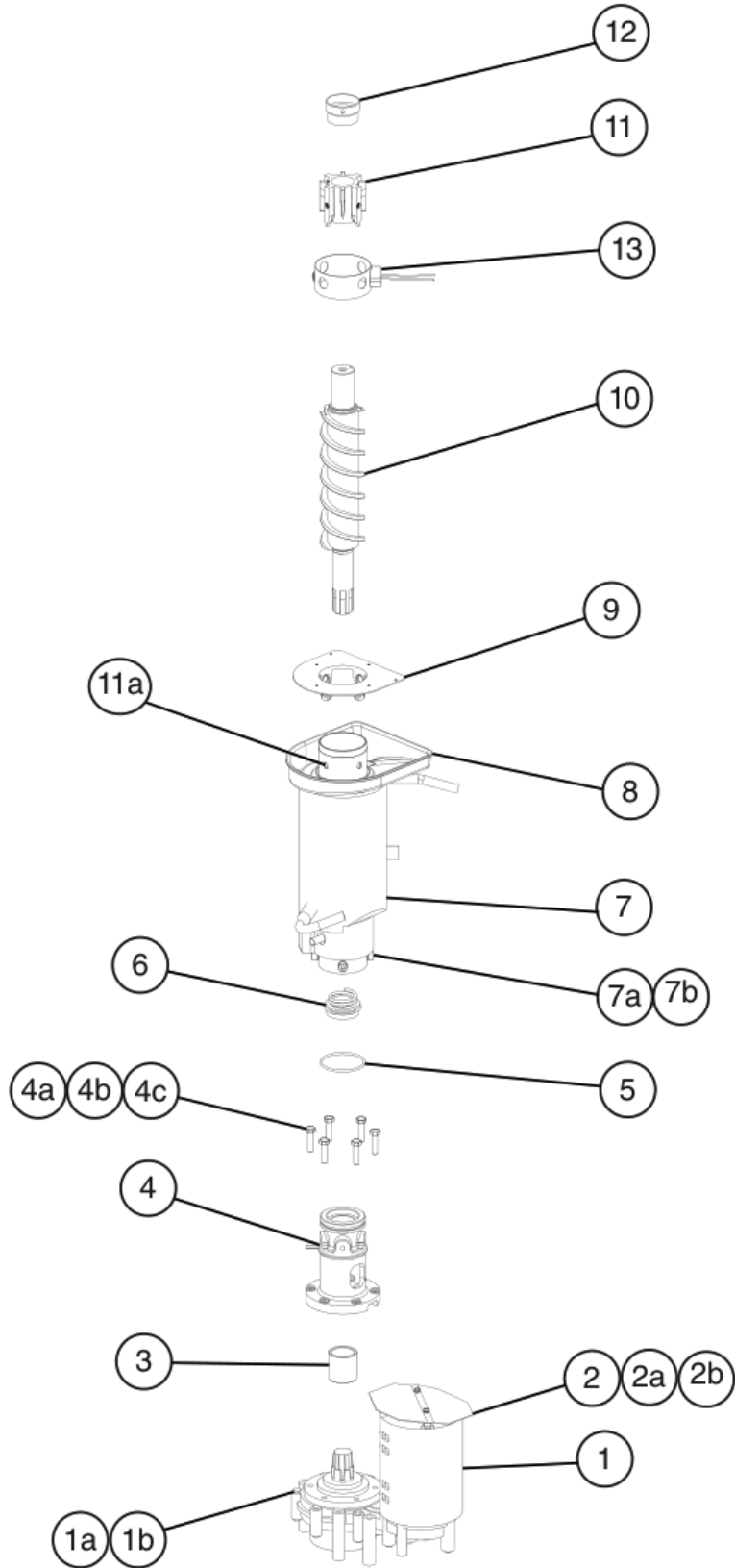

Title: B. Icemaking Unit Model: FD-1002M_J(Z)(-C)(-CB)											
Index No.	Description	Material or Model Number	Part Number	Required Number							
				F-0 to L-0	L-1 to L-2	L-2 to P-0					
1	Gear Motor	SP-5582	4A2007-01	1	-						
			4A6946-01		1	1					
1a	Gear Motor Bolt		7S12-0811	3	3	3					
1b	Washer		7L22-0800	3	3	3					
2	Gear Motor Barrier		4A4029-01	1	-						
			3B1054-01		1	1					
2a	Truss Head Screw	4x8, SS	7C32-0408	2	2	2					
2b	Rubber Washer		4A5268-01	2	2	2					
3	Spline Coupling		414137-01	1	1	1					
4	Housing		2A1977G01	1	-						
			3B0186G01		1	1					
4a	Hex Head Bolt	8x30, SS	7B02-0830	6	6	6					
4b	Plain Washer		7W22-0800	6	6	6					
4c	Split Lock Washer		7L22-0800	6	6	6					
5	O-Ring		4A4755-02	1	1	1					
6	Mechanical Seal		432492-01	1	1	-					
			432492-03			1					
7	Evaporator		2A7209G01	1	1	1					
7a	Socket Head Cap Screw		7S12-0812	4	4	4					
7b	Split Lock Washer		7L22-0800	4	4	4					
8	Drip Pan		2A7187-01	1	1	1					
9	Flange		352713-01	1	1	1					
10	Auger		120863G02	1	1	1					
11	Extruding Head		3A2176G01	1	1	1					
11a	Seal Bolt		P01768-02	4	4	4					
12	Cutter		427183G01	1	1	1					
13	Evaporator Heater		4A2292-01	1	1	1					

**C. Water Circuit**  
**FD-1002M\_J(Z)(-C)(-CB)**  
F-0 to P-0

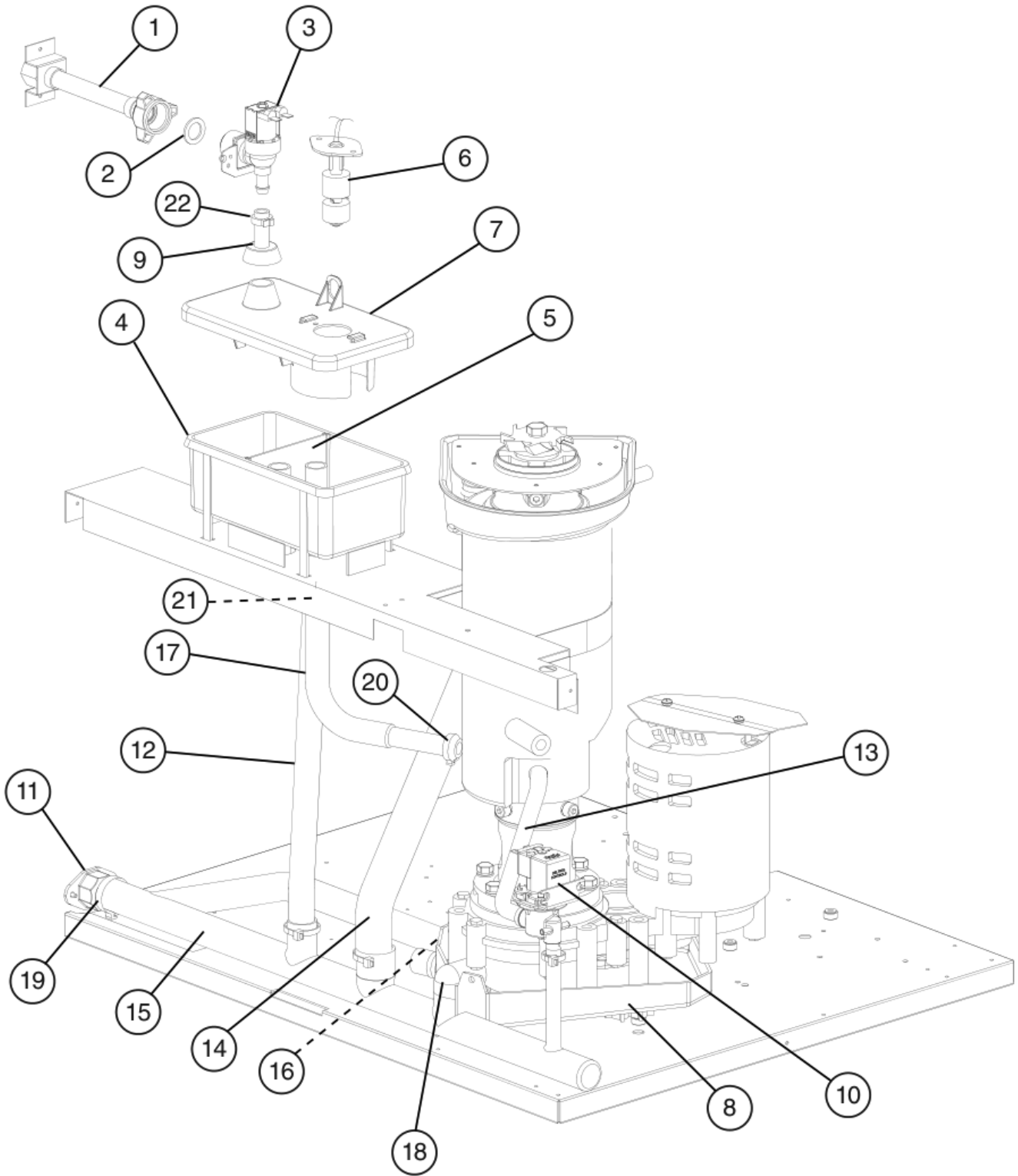

Title: C. Water Circuit Model: FD-1002M_J(Z)(-C)(-CB)												
Index No.	Description	Material or Model Number	Part Number	Required Number								
				F-0 to L-0	L-1 to L-2	M-0 to M-1	M-2 to P-0					
1	Water Supply Pipe		4A7116G01	1	1	1	1					
2	Washer		413854-03	1	1	1	1					
3	Inlet Water Valve		4A5309-01	1	1	1	1					
4	Reservoir		2A0753-01	1	1	1	1					
5	Reservoir Separator		4A1255-01	1	1	1	1					
6	Float Switch		3B1240G01	1	1	1	1					
7	Reservoir Cover		214810-01	1	1	1	1					
8	Drain Pan		323765G02	1	1	1	1					
9	Reservoir Inlet		4A0869-01	1	1	1	1					
10	Drain Valve		4A2772-02	1	1	1	1					
11	Drain Fitting		4A5528-01	1	1	1	1					
12	Vinyl Hose	L=405 mm	7725-1923	1	-							
			7725B1923		1	1	1					
13	Silicone Hose	L=185 mm	7730I3896	1	1	1	1					
14	Vinyl Hose	L=460 mm	4A0658L01	1	1	1	1					
15	Drain Hose		3A8198-01	1	1	1	-					
			3A8198-02				1					
16	Vinyl Hose	L=30 mm	7725-1923	1	1	1	1					
17	Reservoir Hose		4A1165-06	1	1	1	1					
18	Elbow		4A5624-01	1	1	1	1					
<b>Hose Clamps</b>												
19	Hose Clamp	26-30 mm	4A2017-02	1	1	1	1					
20	Hose Clamp	17-20 mm	4A2017-05	1	1	1	1					
21	Hose Clamp	19-22 mm	4A2017-06	1	1	1	1					
22	Hose Clamp	14-15 mm	4A2017-08	1	1	1	1					

**D. Control Box Assembly**  
**FD-1002M\_J(Z)(-C)(-CB)**  
F-0 to P-0

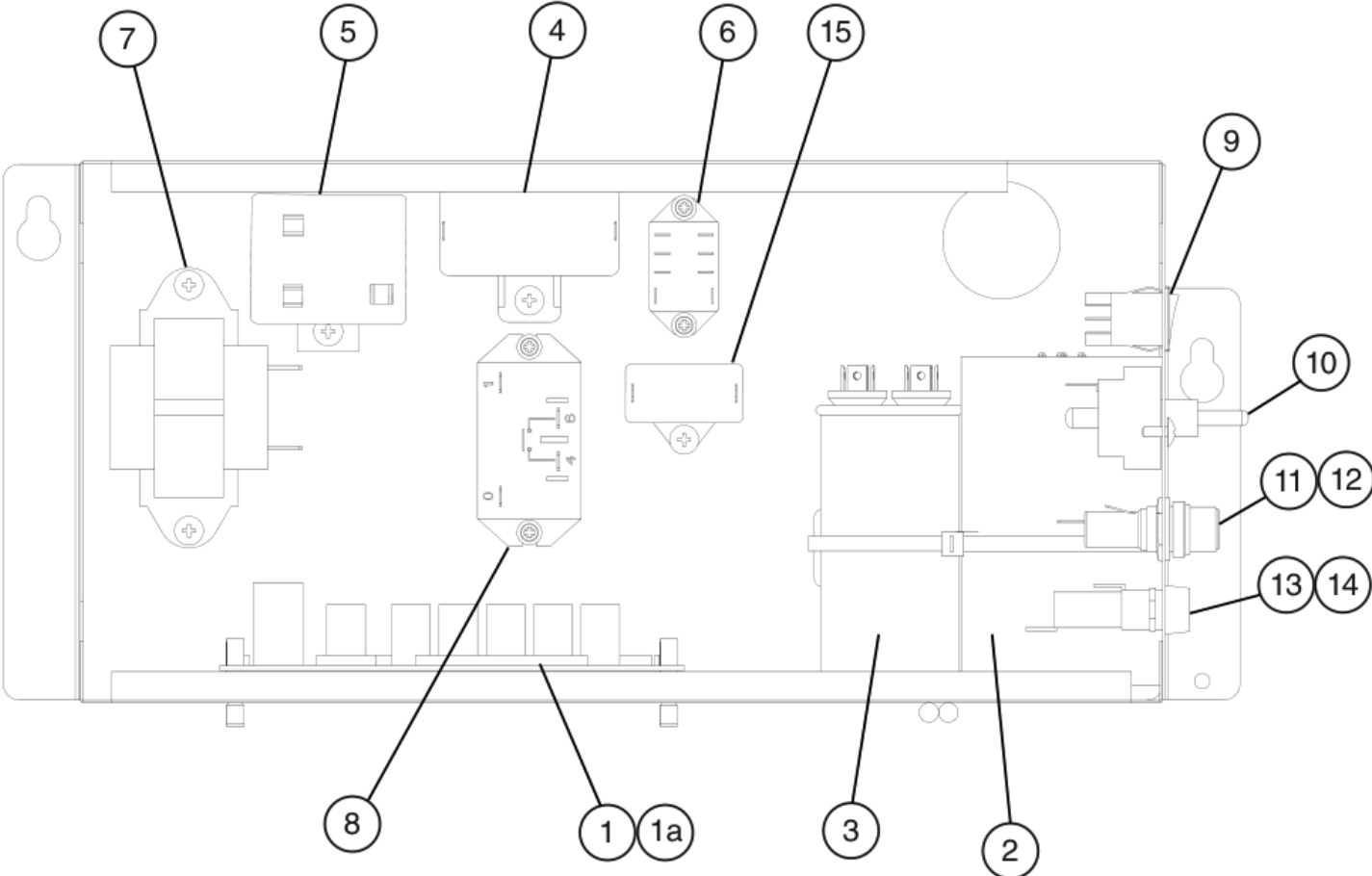

Title: D. Control Box Assembly Model: FD-1002M_J(Z)(-C)(-CB)											
Index No.	Description	Material or Model Number	Part Number	Required Number							
				F-0 to G-1 (L)	G-1 (M) to N-2	N-3 P-0					
1	Control Board		2A8054-01	1	-						
			2A9093-01		1	-					
			2A9874-01			1					
1a	Control Board Support		4A0336-03	4	4	4					
2	Start Capacitor	340-408MFD, 250VAC	3A0076-24	1	1	1					
3	Run Capacitor	40MFD, 370VAC	3A2005-13	1	1	1					
4	Gear Motor Capacitor	24MFD, 250VAC	4A2273-01	1	1	1					
5	Start Relay		4A1107-22	1	1	1					
6	Compressor Control Relay		4A6558-01	1	1	1					
7	Control Transformer		4A0557-01	1	1	1					
8	Compressor Relay		4A3140-01	1	1	1					
9	Control Switch		4A0558-01	1	1	1					
10	Power Switch		4A2332-01	1	1	1					
11	Fuse Holder (Control)		4A5443-01	1	1	1					
11	Fuse (Control)	AGC-1A, 250VAC	4A0893-01	1	1	1					
13	Fuse Holder (Gear Motor)		4A3449-02	1	-						
			4A6101-01		1	1					
14	Fuse (Gear Motor)	GMD-3A, 250VAC Slow Blow	4A0893-06	1	1	1					
15	Fan Motor Capacitor	FD-1002MAJ-C(-CB) 5MFD, 250VAC	443192-02	1	-						
			4A6435-02		1	1					

**E. Accessories & Labels**  
**FD-1002M\_J(Z)(-C)(-CB)**  
 F-0 to P-0

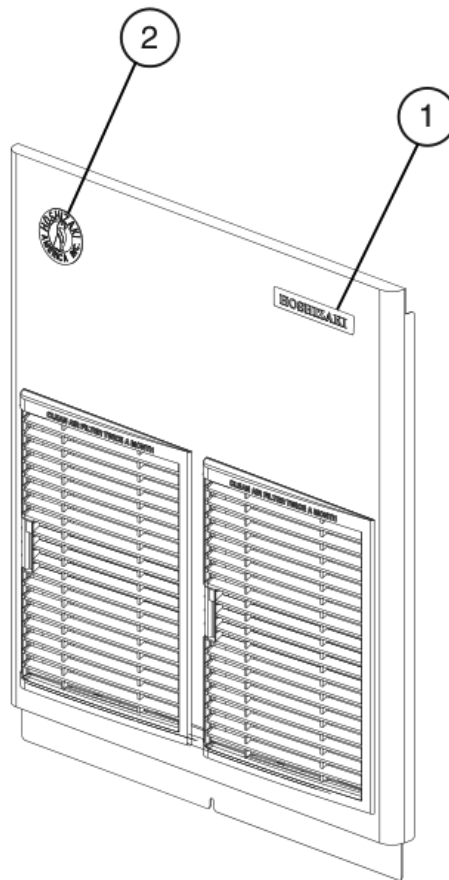

Title: E. Accessories & Labels    Model: FD-1002M_J(Z)(-C)(-CB)				Required Number							
Index No.	Description	Material or Model Number	Part Number	F-0 to G-1 (K)	G-1 (L) to P-0						
				1	Hoshizaki Emblem Label		4A0560-01	1	1		
2	Penguin Label		4A0526-01	1	-						
			475552L02		1						
3	Universal Brace		4A0363-01	2	2						
3a	Hex Bolt		7B02-0512	4	4						