



HOSHIZAKI

Parts List

Modular Cubelet
Serenity Series
Models
FS-1500MLH-C



hoshizakiamerica.com

Number: 71333
Issued: 7-25-2011
Revised: 3-22-2019

CONTENTS

Auxiliary Codes.....	3
Note About Ordering Parts	3
A. Main Assembly & Refrigeration Circuit	4
B. Icemaking Unit.....	7
C. Water Circuit.....	10
D. Control Box Assembly.....	12
E. Accessories & Labels	14

Auxiliary Codes

FS-1500MLH-C	A-0	June 2011
	B-0	January 2012
	B-1	March 2012
	B-2	December 2012
	C-0	January 2013
	C-1	July 2013
	D-0	January 2014
	E-0	October 2015
	F-0	January 2016
	F-1	March 2016
	G-0	February 2017
G-1	April 2017	

Auxiliary Code Breakdown

The auxiliary code is the first two characters in the serial number. The first character indicates the year. Years progress or regress in alphabetical order. The series runs from "A" through "V" and the letters "I" and "O" are skipped. The second character indicates significant part changes within a year. Base is "0" and this number advances for each change. In cases where there is a letter in parentheses, this designates the month. This is the last character in the serial number. The series runs from "(A)" through "(M)" and the letter "(I)" is skipped. This designation is only included when identifying a parts change within an auxiliary code.

Note About Ordering Parts

Most assemblies cannot be ordered as complete units; parts in the assemblies generally must be ordered separately.

A. Main Assembly & Refrigeration Circuit
FS-1500MLH-C
 A-0 to G-1

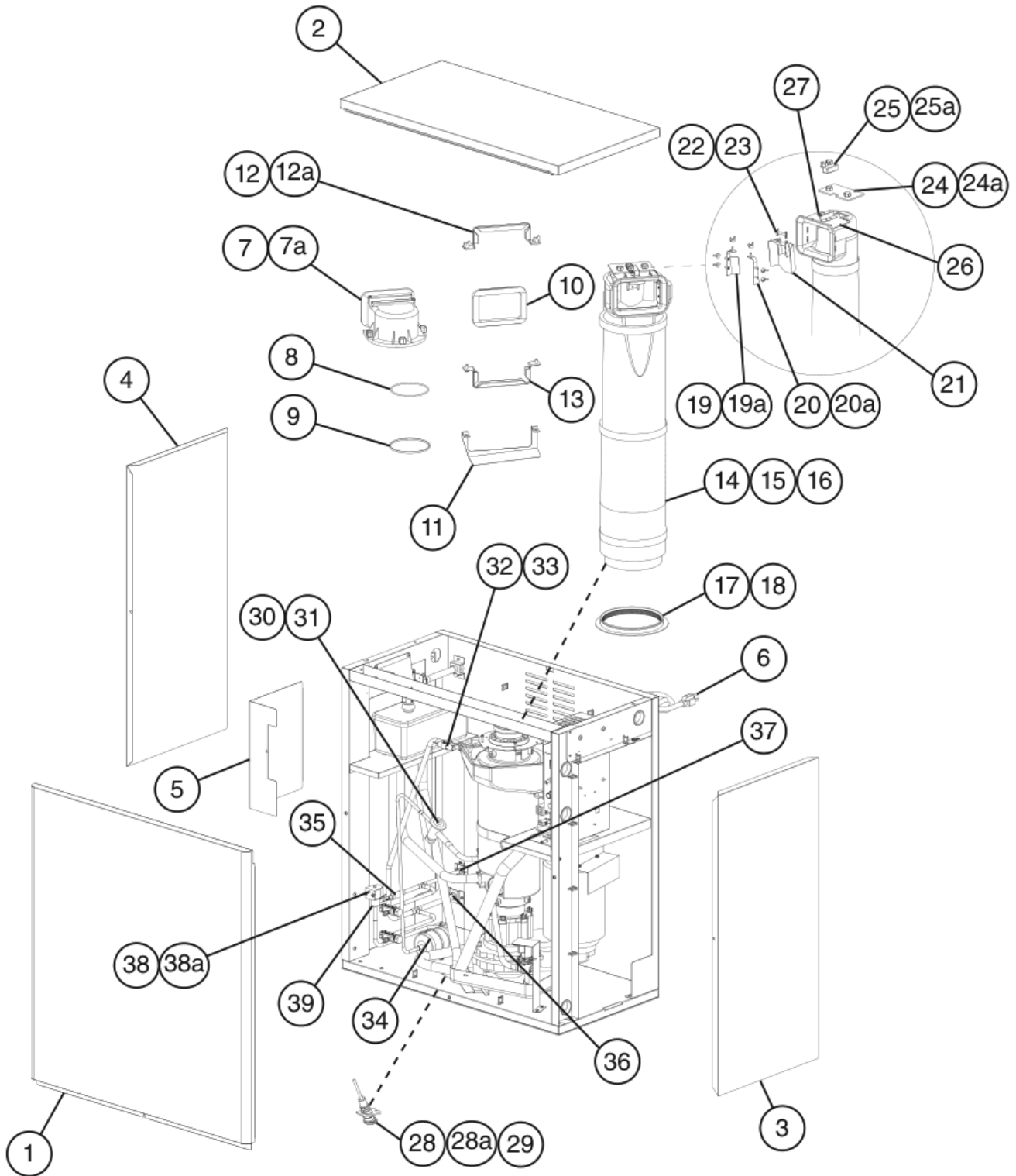

Title: A. Main Assembly & Refrigeration Circuit Model: FS-1500MLH-C											
Index No.	Description	Material or Model Number	Part Number	Required Number							
				A-0 to F-0	F-1 to G-1						
Main Assembly											
1	Front Panel		2A6492-01	1	1						
2	Top Panel		2A6491-01	1	1						
3	Right Side Panel		2A6489G01	1	1						
4	Left Side Panel		2A6490G01	1	1						
5	Control Box Cover		3A6671-01	1	1						
6	Power Cord		4A1773-01	1	1						
7	Spout		105378G01	1	1						
7a	Thumbscrew		415949G11	3	3						
8	O-Ring		4A4755-05	1	1						
9	Nylon Ring		431736-01	1	1						
10	Spout-to-Chute Packing		327040-01	1	1						
11	Drip Guide		3A1628-01	1	1						
12	Upper Spout-to-Chute Strap		3A6912-02	1	1						
12a	Wing Nut		7E12-0600	2	2						
13	Lower Spout-to-Chute Strap		3A6913G01	1	1						
14	Chute		216219-01	1	1						
15	Chute Insulation		216220-01	1	1						
16	Tie		436531G02	3	3						
17	Chute Packing		432877-02	1	1						
18	Ring		327427-01	1	1						
19	Chute Baffle A		341012G01	1	1						
19a	Wing Nut		7E12-0400	3	3						
20	Chute Baffle B		341013G01	1	1						
20a	Wing Nut		7E12-0400	3	3						
21	Actuator		436848G02	1	1						
22	Shaft		436851-01	1	1						
23	Snap Pin		715S-0005	2	2						
24	Plate		4A2039-01	1	1						
24a	Thumbscrew		415949G10	2	2						
25	Bin Control 2 Proximity Switch (mechanical bin control)		4A2033-01	1	1						
25a	Thumbscrew		415949G08	2	2						
26	Bin Control 2 Bracket (mechanical bin control)		3A1744G01	1	1						
27	Truss Head Screw (Ground)		7C32-0408	1	1						
28	Bin Control 1 Housing (infrared sensor)		3A3478-01	1	1						
28a	Thumbscrew		415949G11	1	1						
29	Bin Control 1 (infrared sensor)		4A4469-01	1	1						

Title: A. Main Assembly & Refrigeration Circuit Model: FS-150MLH-C											
Index No.	Description	Material or Model Number	Part Number	Required Number							
				A-0 to F-0	F-1 to G-1						
Refrigeration Circuit											
30	Thermostatic Expansion Valve		4A3493-01	1	1						
31	Thermostatic Expansion Valve Cover		4A1168-01	1	1						
32	Thermostatic Expansion Valve Bulb Holder		3A0112-01	1	-						
33	Clamp		443461-01	1	-						
			4A5641-01		1						
34	Drier		4A1338-01	1	1						
35	Strainer		4A1385-01	1	1						
36	Suction Line Coupling		434072-01	1	1						
37	Liquid Line Coupling		426554-01	1	1						
38	Valve Coil		4A3277-01	1	1						
38a	Bolt		4A3277F01	1	1						
39	Pump Down Solenoid Valve		4A3276-01	1	1						

B. Icemaking Unit
FS-1500MLH-C
1/2
A-0 to C-0

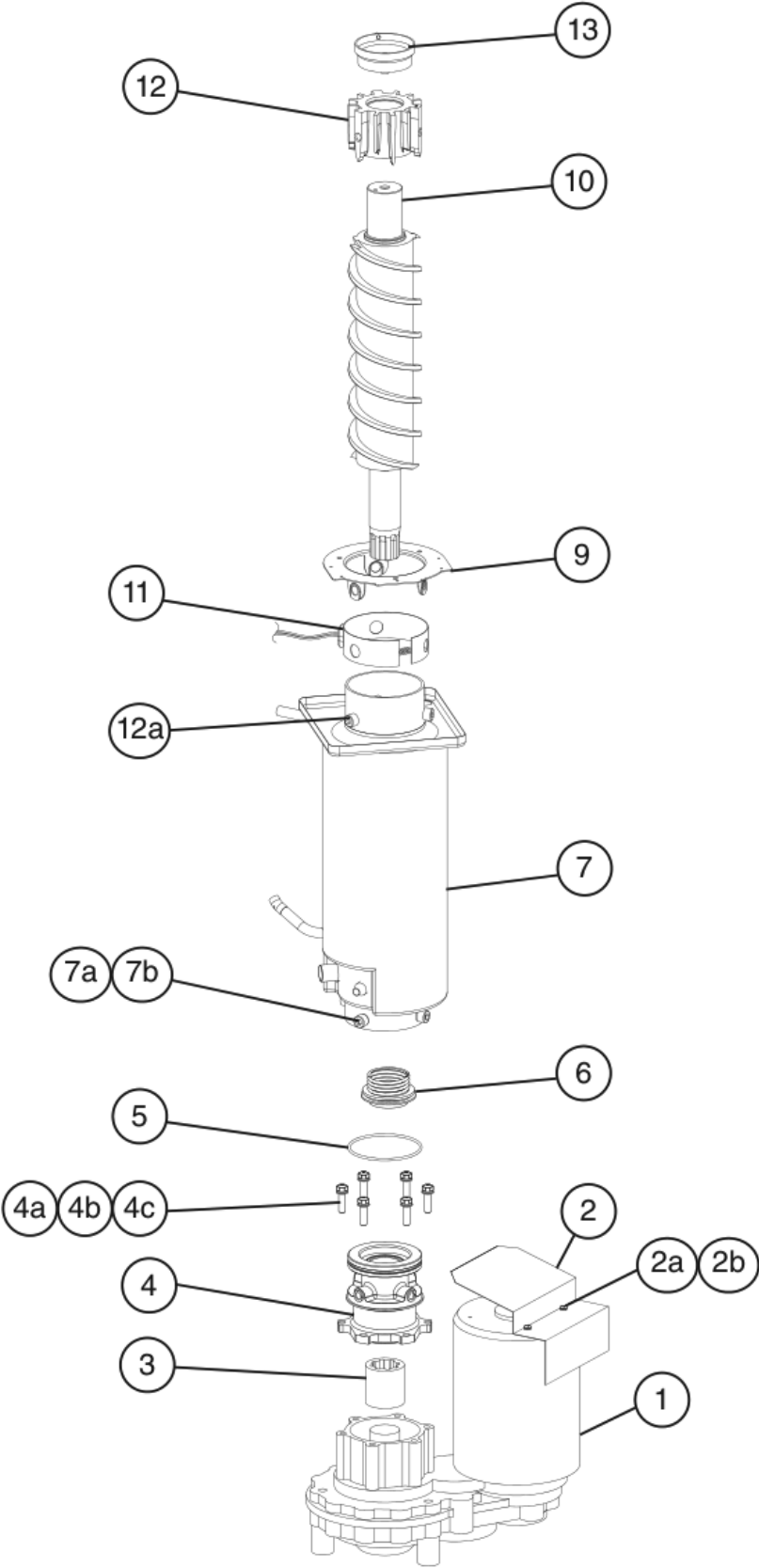

B. Icemaking Unit
FS-1500MLH-C
2/2
C-1 to G-1

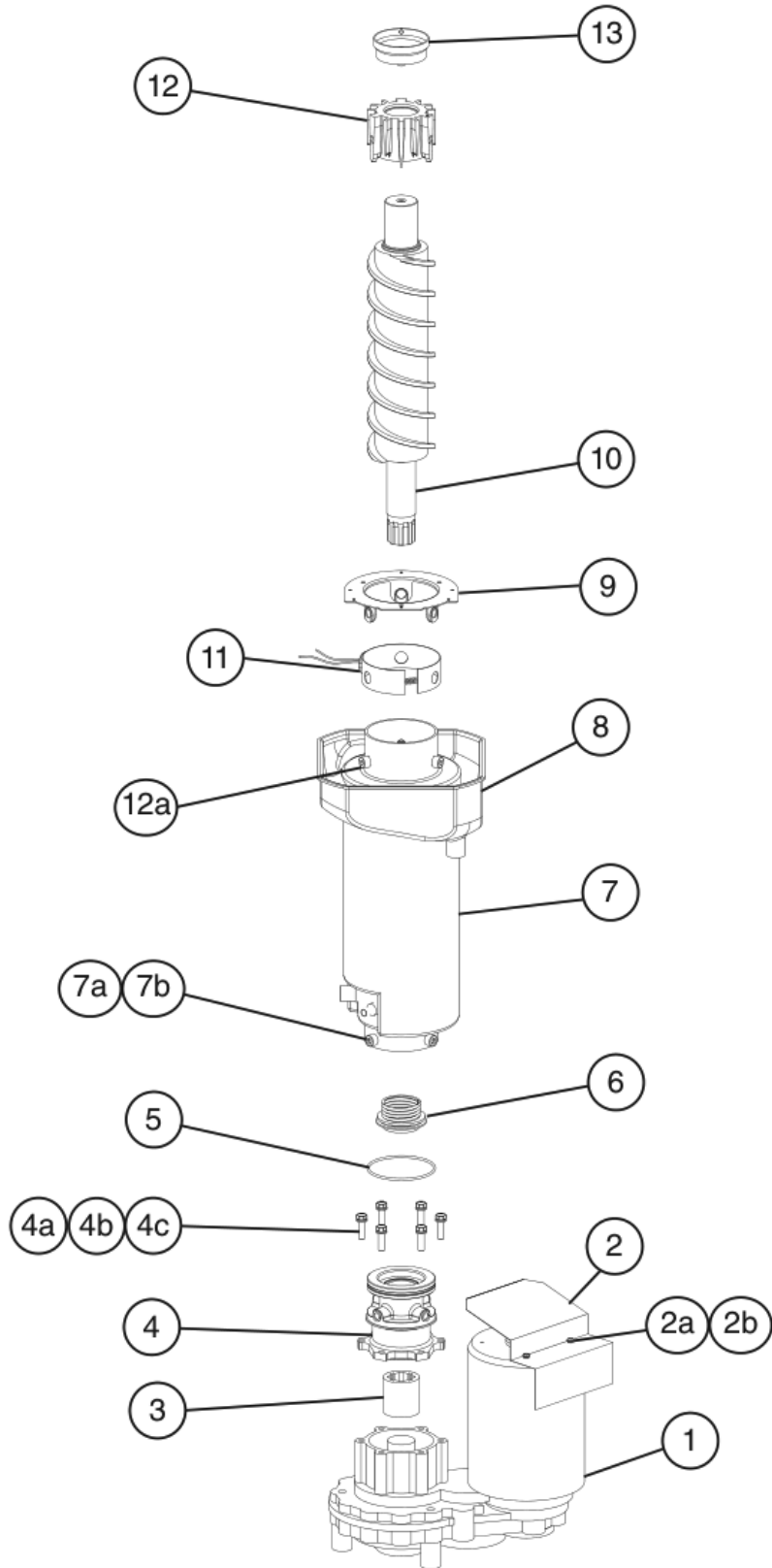

Title: B. Icemaking Unit Model: FS-1500MLH-C												
Index No.	Description	Material or Model Number	Part Number	Required Number								
				A-0 to C-0	C-1 to G-1							
1	Gear Motor		2U0129-01	1	1							
2	Gear Motor Barrier		3A1639-01	1	1							
2a	Truss Head Screw	4x8, SS	7C32-0408	2	2							
2b	Rubber Washer		4A5268-01	2	2							
3	Coupling		420372-01	1	1							
4	Housing		206509G02	1	1							
4a	Hex Head Bolt	8x25, SS	4A5640-01	6	6							
4b	Flat Washer	M8, SS	7W22-0800	6	6							
4c	Split Lock Washer	M8, SS	7L22-0800	6	6							
5	O-Ring		4A4755-04	1	1							
6	Mechanical Seal		432493-01	1	1							
7	Evaporator (C-1 and later utilize separate drip pan and flange - item 8 and 9)		2A3316G02	1	-							
			2A7005G01		1							
7a	Split Lock Washer	M10, SS	7L22-1000	4	4							
7b	Socket Head Cap Screw	10x20	7S12-1020	4	4							
8	Drip Pan		2A6885-01		1							
9	Flange		352714-01	1	1							
10	Auger		120864G02	1	1							
11	Evaporator Heater		4A4335-01	1	1							
12	Extruding Head		264203G02	1	1							
12a	Seal Bolt		474757G02	3	3							
13	Cutter		315736G01	1	1							

C. Water Circuit
FS-1500MLH-C
A-0 to G-1

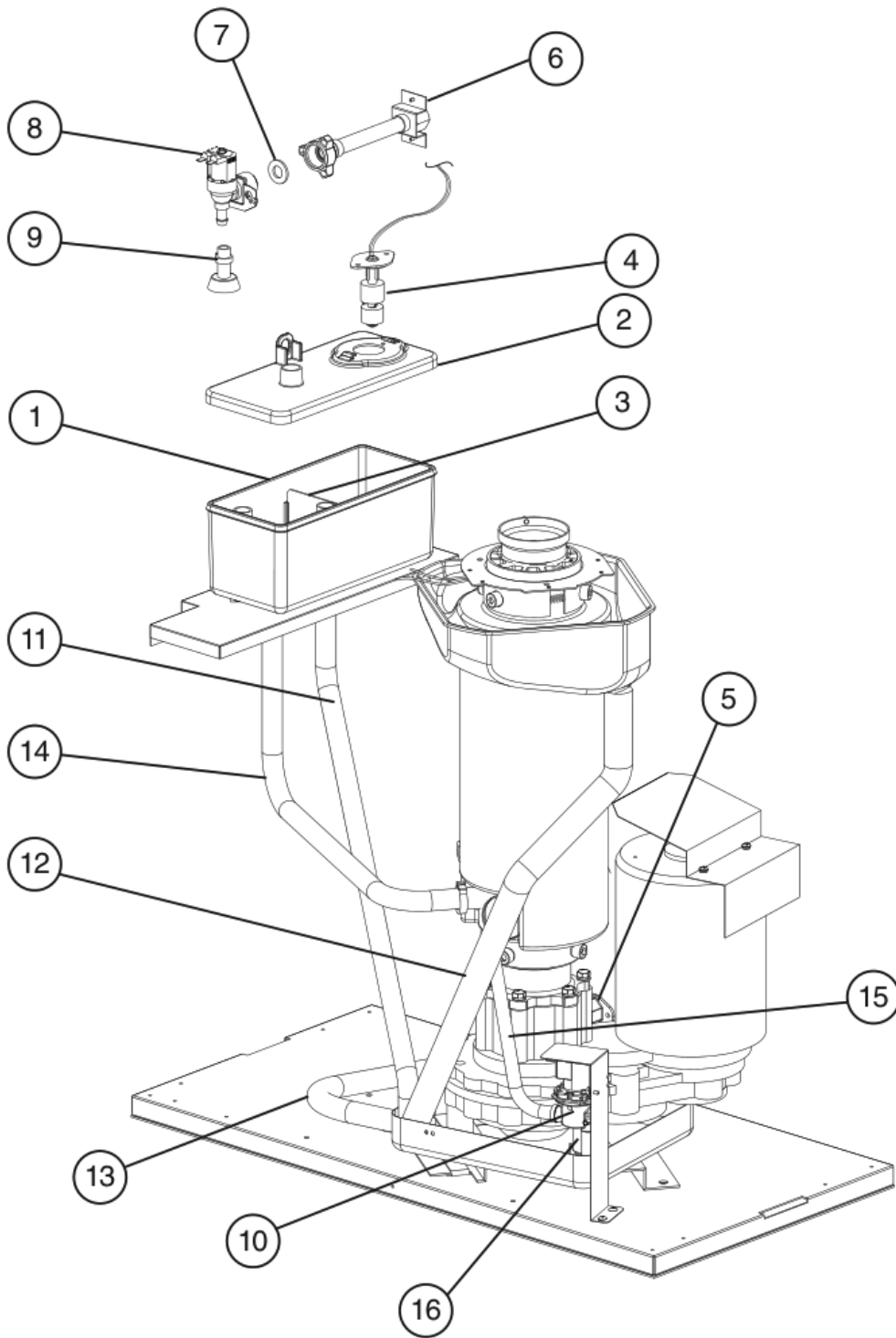

Title: C. Water Circuit Model: FS-1500MLH-C											
Index No.	Description	Material or Model Number	Part Number	Required Number							
				A-0 to B-0	B-1 to G-1						
1	Reservoir		208125-01	1	1						
2	Reservoir Cover		208126-01	1	1						
3	Reservoir Separator		423538-02	1	1						
4	Float Switch		435490-01	1	1						
5	Drain Fitting		4A0776G01	1	-						
			4A5527-01		1						
6	Water Supply Pipe		4A0891G01	1	-						
			4A0891G02		1						
7	Washer		413854-03	1	1						
8	Inlet Water Valve		4A0865-01	1	-						
			4A5309-01		1						
9	Reservoir Inlet		4A0869-01	1	1						
10	Drain Valve		4A2772-01	1	1						
11	Vinyl Hose	L=680 mm	7725-1923	1	1						
12	Vinyl Hose	L=680 mm	7725-1923	1	-						
		L=630 mm	4A0658L01		1						
13	Vinyl Hose	L=411 mm	7725-1923	1	-						
		L=400 mm	7716-2025		1						
14	Silicone Hose	L=540 mm	4A1551-01	1	1						
15	Silicone Hose	L=280 mm	7730I3896	1	1						
16	Silicone Hose	L=60 mm	7730I3896	1	1						
Hose Clamps											
	Hose Clamp	21-26 mm	4A2017-01	2	2						
	Hose Clamp	14-15 mm	4A2017-08	1	1						

D. Control Box Assembly
FS-1500MLH-C
A-0 to G-1

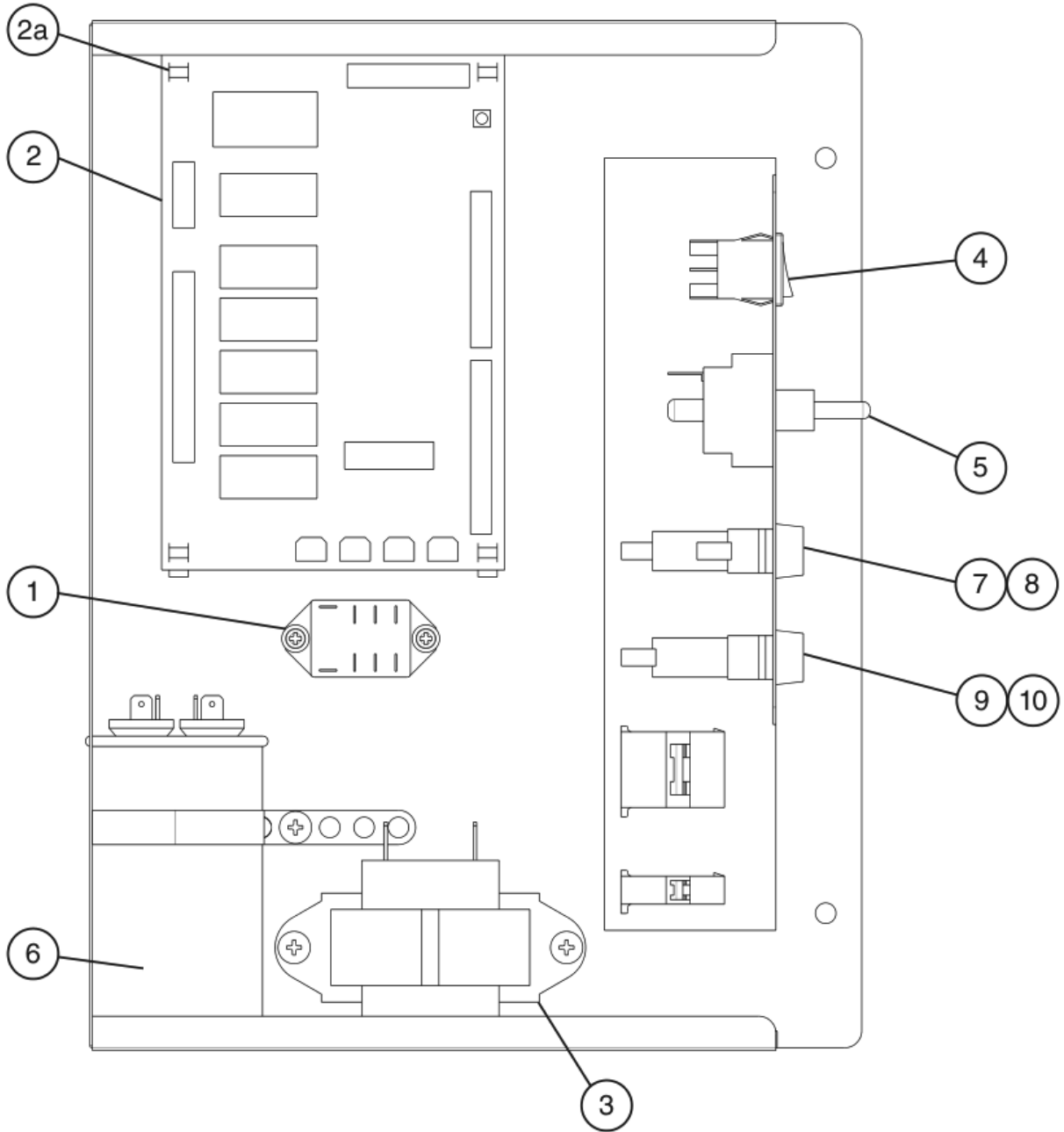

Title: D. Control Box Assembly Model: FS-1500MLH-C											
Index No.	Description	Material or Model Number	Part Number	Required Number							
				A-0 to B-0 (A)	B-0 (A) to G-1						
1	Gear Motor Protect Relay (compressor control relay)		418271-03	1	1						
2	Control Board		2A8054-01	1	1						
2a	Control Board Support		4A0336-03	4	4						
3	Control Transformer		4A0557-01	1	1						
4	Control Switch		4A0558-01	1	1						
5	Power Switch		4A2332-01	1	1						
6	Gear Motor Capacitor	65MFD, 250VAC	4A5450-01	1	1						
7	Fuse Holder (control)		4A3449-01	1	-						
			4A5443-01		1						
8	Fuse (control)	AGC-1A, 250VAC	4A0893-01	1	1						
9	Fuse Holder (gear motor)		4A3449-02	1	1						
10	Fuse (gear motor)	GMD-7A, 125VAC Slow Blow	4A3804-01	1	1						

E. Accessories & Labels
FS-1500MLH-C
 A-0 to G-1

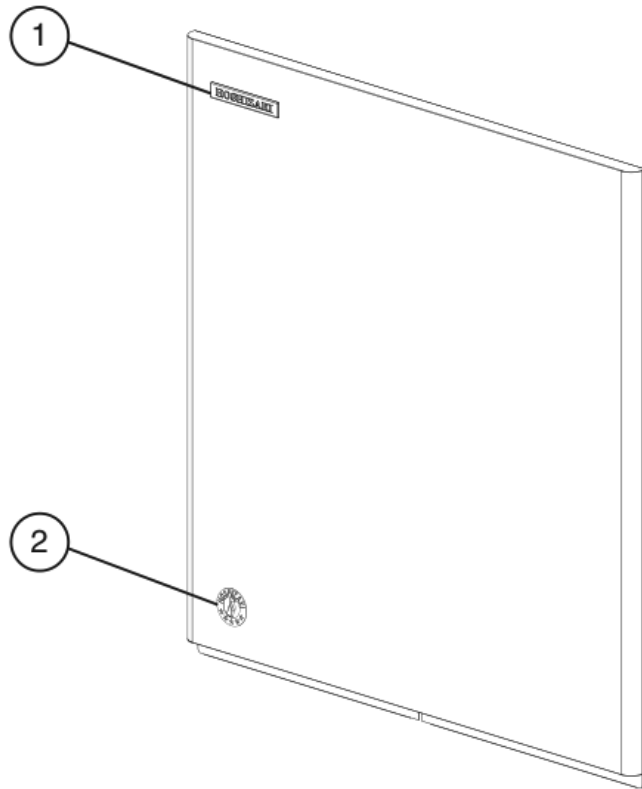

Title: E. Accessories & Labels Model: FS-1500MLH-C											
Index No.	Description	Material or Model Number	Part Number	Required Number							
				A-0 to G-1							
1	Emblem		4A0560-01	1							
2	Penguin Label		475552L02	1							
3	Universal Bracket		4A3668-01	2							
3a	Hex Bolt	5xx2, SS	7B02-0512	4							
3b	Self-Tapping Bolt		7P1111234	4							